

WORK LIGHTS



LIGHTING SOLUTIONS
FOR HIGH PERFORMANCE

Work lights of the future

The sophisticated SCANGRIP work lights are second-to-none and made for real professionals who need the best tool they can get for the task. The full product line-up covers all kinds of work light solutions with superior quality across the entire range. These are lights made for work and built to last.

Latest technologies for best performance

SCANGRIP constantly push back the boundaries of LED lighting and battery technology, creating new cutting-edge work lights. We always reach for that extra brightness, that extra operation time, those little touches that make a real difference when you need the best work light you can get. We guarantee to provide you with only premium products for optimal performance.

Extreme durability and functional design

SCANGRIP work lights are extremely durable and made to do the job again and again. The entire product line is sturdy and endures the really demanding working environment which expose professional workers and their tools to rough, wet, and dirty conditions. The lights are covered by a high IP protection level to resist even outdoor use in all kinds of weather.

Extended warranty

Our lights meet the highest quality standards. They are so good that we offer a warranty extension of 3 years for all SCANGRIP work lights and 5 years for our FOR LIFE work lights. Because we stand by the products we offer.

Reinventing the future of LED work lights

We are taking an ambitious strategic step forward by committing to develop LED work lights with minimized environmental impact while at the same time improving energy efficiency and expanding the lifespan.

The FOR LIFE concept represents a pioneering approach that focuses on reinventing the design and functionality of LED work lights and optimizing energy efficiency to the utmost. With sustainability as the focus point, we have rethought the traditional standards, pushing the boundaries to extend the lifespan of our lighting solutions.

13 of our top-selling work lights have undergone a complete transformation when it comes to visual design and come with a range of enhanced features that provide numerous benefits to the end-user. Read more about the enhancements on page 4.



Lifespan more than doubled
Highest energy efficiency
Maximized performance



Find
out
more

SCANGRIP - work lights of the future

 <p>FOR LIFE concept</p> <p>04</p>	 <p>MAG series</p> <p>06</p>	 <p>UNIFORM series</p> <p>08</p>	 <p>SLIM series</p> <p>10</p>	 <p>STICK LITE series</p> <p>12</p>
 <p>STAR LITE</p> <p>14</p>	 <p>LINE LIGHT hand lamps</p> <p>16</p>	 <p>Bonnet lights</p> <p>18</p>	 <p>Headlamps</p> <p>22</p>	 <p>STAR</p> <p>26</p>
 <p>NOVA series</p> <p>28</p>	 <p>VEGA LITE series</p> <p>36</p>	 <p>AREA LITE CO</p> <p>38</p>	 <p>STANDS and SUSPENSIONS</p> <p>40</p>	 <p>SITE LIGHT series</p> <p>42</p>
 <p>ROPE LIGHT</p> <p>44</p>	 <p>FLEX WEAR</p> <p>46</p>	 <p>FLASH LIGHT series</p> <p>47</p>	 <p>LINE LIGHT concept</p> <p>50</p>	 <p>LINE LIGHT for lifts</p> <p>52</p>
 <p>LINE LIGHT for customized installation</p> <p>54</p>	 <p>Technical specifications</p> <p>56</p>			

for **LIFE**



What's new?

- Multi-LED design and new electronic design with improved efficiency up to 50 %
- OPTILight setting for optimized light and runtime
- From 4 years design life to 10 years
- From 500 to 1000 battery charging cycles
- Temperature surveillance to protect the lamp
- Rough service certified

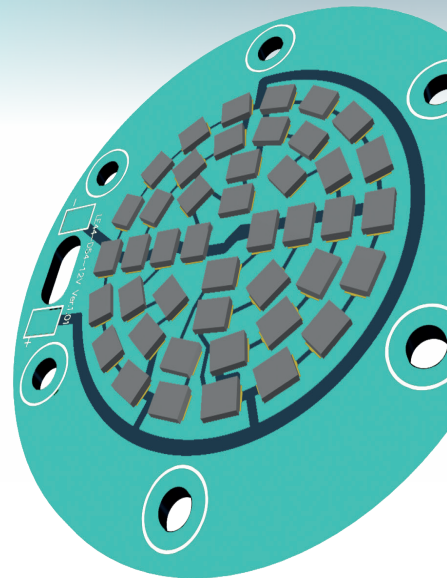

Use of recycled materials
e.g., aluminium

100 % recycled

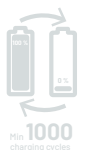
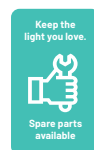

Warranty extended
from 3 to 5 years



Constant lumen performance

You can trust that a SCANGRIP work light maintains a constant lumen output as it fulfills the strict requirements of the European Standard EN 13032-1. The FOR LIFE work lights are designed with advanced components and effective heat dissipation to ensure optimal performance.

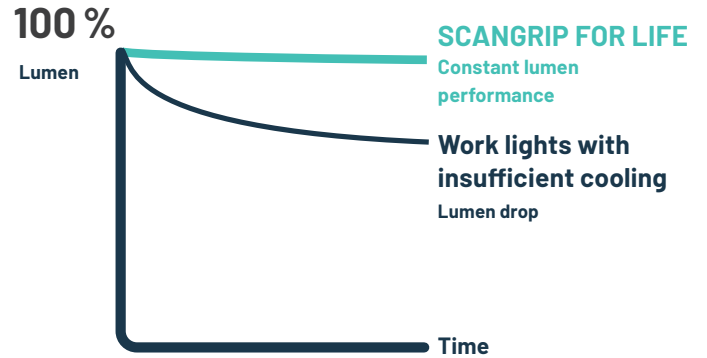

Environmental impact over time



FOR LIFE work lights



10 years of use

Other work lights



4 years of use

4 years of use

2 years of use....

MAG – Europe’s most bestselling work lights even further improved

// The rechargeable handheld work lights everybody knows – and loves! With significantly improved light output, battery upgrade and even more functionality, the popular MAG work lights offer great value in every workshop operation.

The MAG series consist of universal and powerful multipurpose work lights that all professional users must have!

- Significantly improved with higher lumen output
- Integrated work light and flashlight functionality in one
- Strong built-in magnetic holders and retractable hooks for handsfree operation
- New stepless dimmer function

// MAG PRO WIRELESS - more flexibility with wireless charging

MAG PRO comes in a version with the option of wireless charging using the accessory SCANGRIP CHARGING PAD 03.5928, which can be purchased separately. The charging pad offers a convenient and uncomplicated way to charge your work light without the need for extra cables.

The charging pad is designed so that the work light automatically “slides into place” over the powerful magnets on the back. This means that MAG PRO WIRELESS can be charged also in a vertical position. The charging pad is prepared for fixed mounting, enabling efficient use of space in the workshop.

NEW



MAG PRO WIRELESS

€ 74.90

03.5691

Work light with COB LEDs and spotlight providing 600 lumen

NEW



CHARGING PAD

€ 29.90

03.5928

Optional accessory for MAG PRO WIRELESS. Can also be used for charging most mobile phones and other compatible devices.

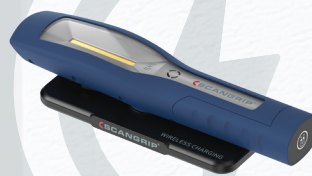

ORIGINAL
SCANGRIP



SINCE 1906

// Updated and more powerful than ever

Taking advantage of the latest high performance LED technology, the MAG range comprises extremely powerful work lights providing significantly improved light output. Compared to the previous MAG 3 and MINI MAG, the new MAG PROs are upgraded to IP54 and have a new design with battery indicator on front.

// Multipurpose with cool design

The characteristic and elegant design of the MAG hand lamps provides an ergonomic and user-friendly grip. Place anywhere you want with the strong built-in magnetic holders and retractable suspension hooks to obtain complete flexibility. The lamp head is flexible and tilts up to 180 degrees.

// Stepless dimmable



MAG PRO, MINI MAG PRO and MAG PEN 3 are upgraded with a stepless dimmer function in the range of 10 to 100 % that enables you to adjust the light output to the work task.

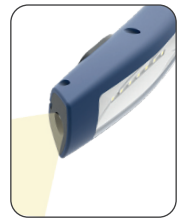
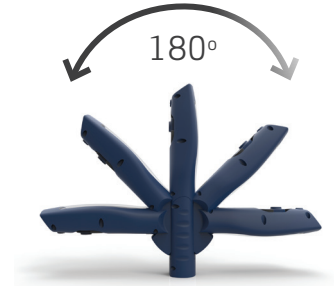

MAG
€ 52.90
03.5400

Work light with SMD LEDs and spotlight providing 300 lumen

EU DESIGN PATENT
2954123



MAG PRO
€ 64.90
03.5690

Work light with COB LEDs and spotlight providing 600 lumen

EU DESIGN PATENT
2954123

MINI MAG PRO
€ 42.90
03.5692

Work light with COB LEDs and spotlight providing 200 lumen

EU DESIGN PATENT
3451038



// Rechargeable inspection penlight

Upgraded with the highly efficient COB LED technology, MAG PEN 3 provides powerful illumination both from the lamp head and precision top light.

The design is compact allowing access in the most inaccessible places. It comes with built-in magnets both in the turnable clips and at the bottom for flexible positioning.



MAG PEN 3
€ 37.90
03.5116

Pencil work light with COB LEDs and spotlight providing 150 lumen

EU DESIGN PATENT
4070035



UNIFORM – extremely durable work lights



// The UNIFORM series features robust and ergonomically designed handlamps that deliver consistently uniform illumination, making them ideal for any demanding work tasks.

- Rechargeable
- High efficiency multi-LED design
- OPTILight setting for optimized light and runtime with a simple touch
- Compact and flexible design with built-in magnet and clip
- Resistant to water and dust with an IP65 rating

PRODUCT IMPROVEMENTS COMPARED TO PREVIOUS VERSIONS

- Up to 52 % efficiency improvement
- OPTILight functionality
- Dedicated buttons for on/off and brightness levels
- Battery indicator
- Double temperature surveillance to protect the lamp and battery
- Rough service certified

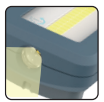

UNIFORM

€ 89.90

03.6208

Rechargeable LED work light with charging base providing 500 lumen

EU DESIGN PATENT PENDING

Extremely durable work light

UNIFORM is a universal LED handlamp with a top light, offering all the functionality you can dream of. The OPTILight setting ensures optimized light and runtime with a simple touch.

UNIFORM is built to endure tough environments, and features a turnable hook, strong magnet, and belt clip for flexible positioning. Designed with user-friendly battery indicator. 20 % recycled material.



Charging base can easily be mounted on the wall



OPTI Light

Optimized light and runtime for your work in one touch.



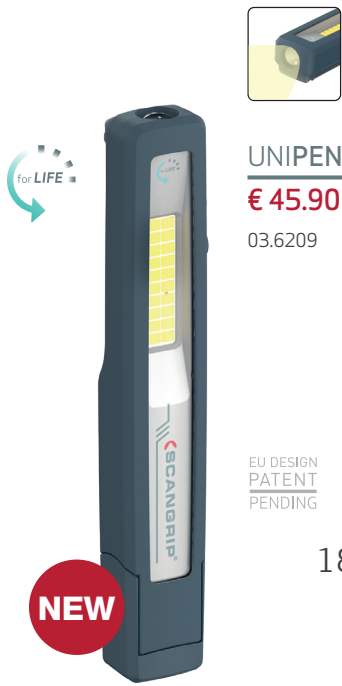

UNIPEN
€ 45.90
03.6209

EU DESIGN
PATENT
PENDING

Convenient 2-in-1 rechargeable LED work light providing 150 lumen

User-friendly design with a top light and OPTILight setting. Pocket clip for easy portability. Battery indicator. 5 % recycled material.

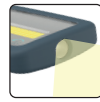

MINIFORM
€ 56.90
03.6207

EU DESIGN
PATENT
PENDING

Handy rechargeable LED work light providing 200 lumen

Pocket-sized and ultra-slim design with top light and OPTILight setting. Battery indicator. 7 % recycled material.



SUPERFORM
€ 61.90
03.5406

Sturdy work light with 5 m cable providing 750 lumen

Outperforming traditional fluorescent work lights

EU DESIGN
PATENT
2954123

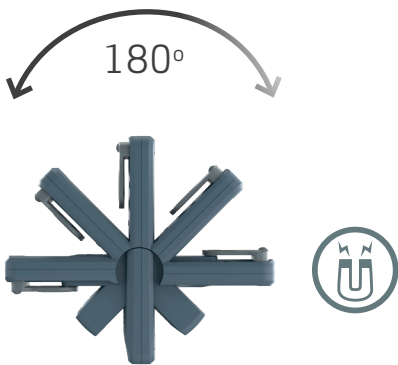

Flexible lamp head tilts up to 180 degrees. Supplied with a strong built-in magnet and a turnable sturdy hook designed to fit the work belt.



UV-FORM
€ 79.90
03.5408

EU DESIGN
PATENT
3451038

Work light with UV-top light (400 nm) providing up to 250 lumen



UV-FORM is a rechargeable LED work light with powerful 1.8 W UV-light on the top. The most powerful UV-light on the market. Basically you get a universal indispensable work light and UV detection in one, and at the same time it replaces special UV detection lights.

The ultraviolet light is intended for leak detection in air-conditioning systems by means of trace elements. Also useful for leak detection of larger, complex refrigeration/freezing appliances, process cooling systems, heat pump systems etc.

SLIM – Ultra-thin rechargeable LED work lights

// The SCANGRIP SLIM light series offers a true, multifunctional 3-in-1 lighting solution for all kinds of application areas.

- Rechargeable
- High efficiency multi-LED design
- OPTILight setting for optimized light and runtime with a simple touch
- Ultra-thin design for reaching narrow and inaccessible areas
- 100 % foldable body, built-in magnet, and hook for flexible positioning

PRODUCT IMPROVEMENTS COMPARED TO PREVIOUS VERSIONS

- Up to 30 % efficiency improvement
- OPTILight functionality
- Dedicated buttons for on/off and brightness levels
- Battery indicator
- Double temperature surveillance to protect the lamp and battery
- Min. 1000 charging cycles

ORIGINAL
SCANGRIP



SINCE 1906



// Ultra-slim light for inspection

The thin, compact design only $\varnothing 9$ mm allows inspection in even the most inaccessible and narrow work areas. This makes the SLIM lights ideal for very demanding and difficult inspection jobs



// Flexible work light

By making use of the built-in magnet, you can place the work light on any magnetic surface and adjust the main light to the most optimal angle. When you fold the lamp, the light transforms into a compact handheld work light that is perfect to carry in your pocket.



// Flashlight function

When folded, the 100-lumen spotlight acts as a powerful flashlight, featuring a convenient and secure grip.

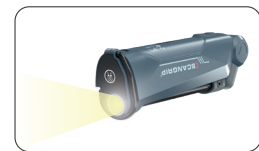

EU DESIGN PATENT PENDING



MINI SLIM

€ 62.90

03.6210

Ultra-thin rechargeable LED work light providing 200 lumen. 18 % recycled material.

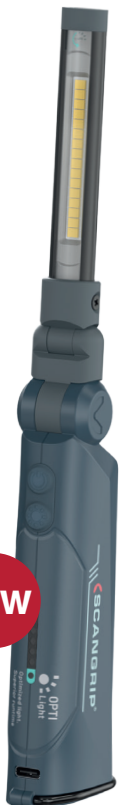

NEW



SLIM

€ 77.90

03.6211

Ultra-thin rechargeable LED work light providing 500 lumen. 13 % recycled material.

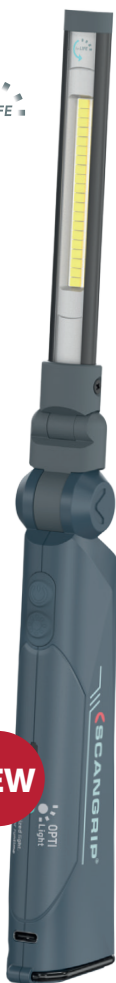

NEW

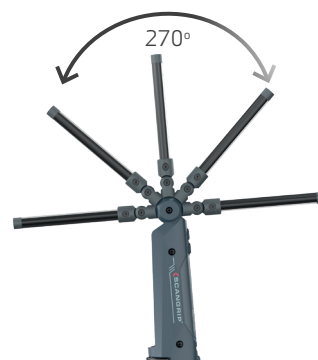

STICK LITE

// Universal hand lamps in slim design

STICK LITE is ideal for those who value good, compact design combined with uncomplicated functionality.

Taking advantage of the highly efficient COB LED technology, the new generation of STICK LITEs provides high performance regardless if it is for everyday use or a tough job. With STICK LITE, you are guaranteed optimal brightness and handy design at a fair price.

- Powerful work light with top light function
- Adjustable light output with stepless dimmer function
- Ultra lightweight for maximum working comfort
- Slim and compact design prepared for the pocket
- Strong built-in magnets for handsfree use

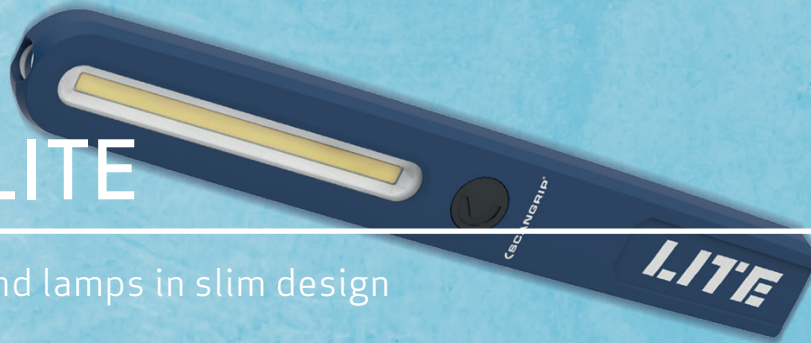

ORIGINAL
SCANGRIP



SINCE 1906

// Handy work lights with fundamental features

STICK LITEs are rechargeable, powerful work lights with torch light function enabling convenient and precise work. STICK LITEs are recommended for everyone who need universal, sturdy and handheld work lights. The practical built-in magnets allow you to benefit from the bright light of the STICK LITEs and still having both hands free for work.

// Ultra lightweight and compact design

The ultra-thin and compact design with round shapes makes STICK LITE comfortable to carry in the pocket ready at hand for the daily inspection tasks. The slim designed work lights are also optimized in weight to provide maximum working comfort.

// Stepless dimmable



The STICK LITE hand lamps are upgraded with a stepless dimmer function in the range of 10 % to 100 % that enables you to easily adjust the light output to the work task.



Ultra-slim, only
13 mm wide



STICK LITE S

€ 24.90

03.5665

Rechargeable work light with top light and stepless dimmer providing up to 200 lumen



STICK LITE M

€ 34.90

03.5666

Rechargeable work light with top light and stepless dimmer providing up to 400 lumen



With strong built-in magnets for positioning on any magnetic surface

STAR LITE

ORIGINAL
SCANGRIP



SINCE 1906

// Universal inspection work light with cable

If you prefer a basic, traditional inspection work light with cable that does the job, STAR LITE is the perfect choice. It is designed for basic inspection work which is carried out at almost any workplace.

Upgraded with the highly efficient COB LED technology, STAR LITE ensures super bright illumination of the work area.





// Bright inspection work light

STAR LITE is the universal, sturdy work light everyone must have as part of the basic equipment of the workshop. It is designed for efficient workshop use and provides an ergonomic and user-friendly design. STAR LITE is fitted with a turnable hook for easy suspension of the lamp.

STAR LITE

€ 34.90

03.5671

Work light with cable
providing 400 lumen

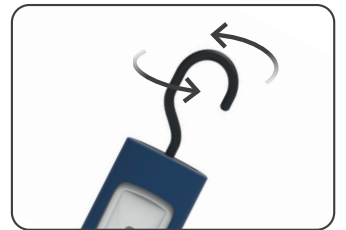

ULTRA SLIM inspection hand lamps

// The sophisticated and streamlined LINE LIGHT inspection hand lamps are made in Denmark, and present a golden example of our ability to push back the boundaries of LED lighting creating work lights with optimal performance, extreme durability and lots of bright functionalities.

- Sturdy and waterproof, IP65
- Ultra-slim design (ø25 mm) allows inspection in even most inaccessible places
- Flexible positioning with adjustable hook with magnet
- Flexible gooseneck fixtures available as optional accessories

ORIGINAL
SCANGRIP



SINCE 1906

MADE IN DENMARK



EU DESIGN
PATENT
4070035



Both lamps are delivered with adjustable hook with clip holder and magnet

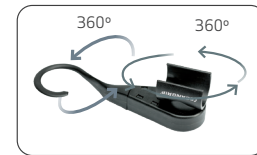

LINE LIGHT C+R

€ 104.90

03.5243

Inspection work lamp with DUAL SYSTEM and top spotlight providing up to 900 lumen



LINE LIGHT R

€ 92.90

03.5244

Rechargeable inspection work lamp with spotlight providing up to 600 lumen

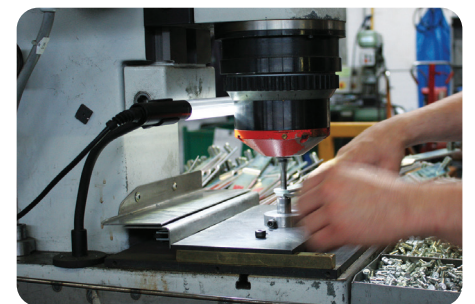
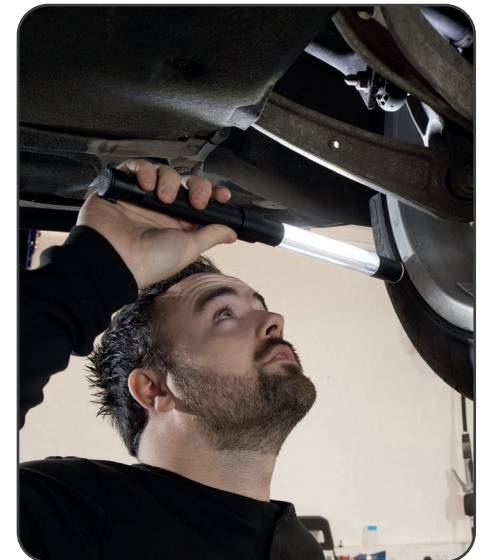

The very slim design with a diameter of only 25 mm makes it possible to illuminate even hard to reach compact areas.

DUAL 2 in 1 SYSTEM

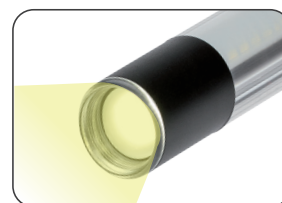

LINE LIGHT *bonnet light*

// Superior bonnet light on the market

- Improved light output (1400 lumen)
- Dust and waterproof, IP65
- Most slim and compact bonnet light on the market
- Extremely low weight, less than 1000 g
- Choose between 2 light settings (50 % or 100 %) for maximized operating time

DUAL 2 in 1 **SYSTEM**

DUAL SYSTEM is new intelligent and innovative lighting functionality.

The new BONNET LIGHT is with DUAL SYSTEM which means both rechargeable and with 5 m rubber cable offering unlimited application possibilities and complete freedom. Very easily you change over: it takes only a second to connect the power cable – or disconnect when needed.

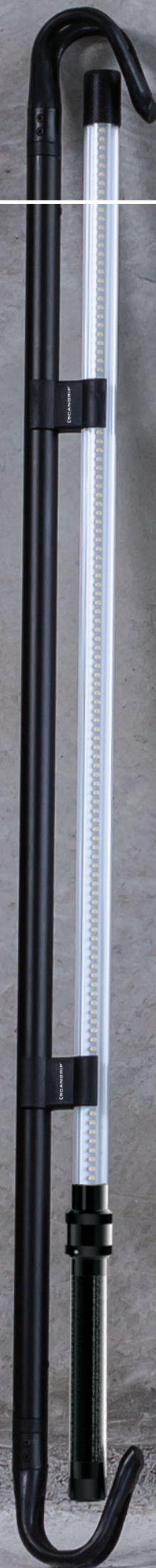

ORIGINAL
SCANGRIP



SINCE 1906

MADE IN DENMARK

EU DESIGN
PATENT
4070035



// Illuminates the entire engine bay

The BONNET LIGHT provides you with an extremely bright and powerful illumination of the entire engine bay.

Supplied with an adjustable telescopic holder with soft-padded hook ends providing a firm and scratch-free grip on the vehicle. The holder is compact and takes up less space in storage.



Without cable the bonnet light might also to be used as a large inspection lamp.



LINE LIGHT BONNET C+R

€ 169.90

03.5240

DUAL 2 in 1 SYSTEM



Inside the cabin the BONNET LIGHT may also be used as work light either mounted by the telescopic holder or mounted onto the windscreen by the flexible arm with suction cup.



// FLEXIBLE suspensions

A range of accessories are available to position the LINE LIGHT lamps



GOOSENECK

€ 26.90

03.5219

20 cm flexible arm with clip holder and ø60 mm suction cup



GOOSENECK

€ 31.90

03.5218

20 cm flexible arm with clip holder and ø60 mm magnet

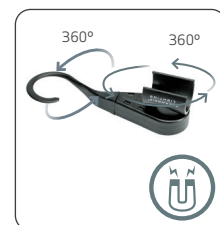

HOOK

€ 11.90

03.5312

Adjustable hook with clip holder and magnet

NOVA BONNET – *powerful bonnet light providing maximum flexibility*

// The NOVA BONNET light provides you with increased flexibility and bright illumination of the engine bay. With the NOVA BONNET, you will have a bonnet light and a flexible NOVA R hand lamp in one single solution.



Use the NOVA BONNET inside the cabin



Use NOVA R separately for inspection work



// Rechargeable and dimmable COB LED work light

Easily mount the NOVA R on the bonnet light via the enclosed bracket, slide it from side to side to position the light and adjust the light output or simply use the hand lamp for inspection work.

Featuring the latest high-performance COB LED technology, NOVA R provides up to 2000 lumen with a uniform and even illumination. The light dimmer function makes it possible to adjust the light into five different levels, and due to the upgraded battery capacity, you can use the lamp for up to 20 hours depending on the light output.

The NOVA BONNET is supplied with an adjustable telescopic holder (1.2-1.7 m) with soft-padded hook ends providing a firm and scratch-free grip on the vehicle. The holder is compact and equipped with a metal bracket. The powerful integrated magnets of NOVA R provides flexible mounting on the bracket. Inside the cabin, the NOVA BONNET may also be used as work light mounted by the telescopic holder.

// High flexibility

The simple and user-friendly design makes it easy to mount and dismount the NOVA R, which allows you to use the lamp for inspection work. NOVA R is easy to carry and is ergonomically designed for a good grip on the handle.

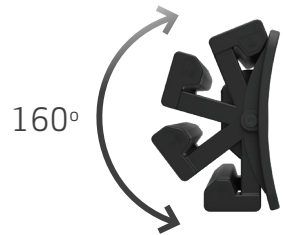

Mount and dismount NOVA R on the bracket



NOVA BONNET

€ 149.90

03.5457



NOVA R 1000/2000 lumen

// ACCESSORIES

Buy accessories separately and transform your NOVA R handlamp into a flexible bonnet light.

BRACKET

€ 21.90

03.5760



BONNET HOLDER

€ 42.90

03.5314

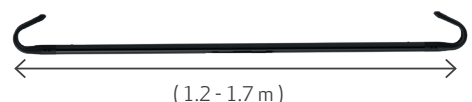

(1.2 - 1.7 m)

HEADLAMPS *for professionals*

// Powerful, hands-free lighting solutions for a wide range of application areas.

- Rechargeable
- Illuminates your entire workspace
- Long duration time
- Easy to operate
- Sensor function with touchless on/off switch

Unlike traditional headlamps that only provide a narrow beam, the I-VIEW and ZONE headlamps are designed to provide optimum work light illuminating your entire work area. With advanced LED technology, these headlamps offer strong and uniform illumination, sparing you from the need for frequently repositioning your head to light up your workspace.

Overall, all the headlamps are comfortable to wear throughout the day and perfect for demanding tasks that require the use of both hands.

// ZOOM - Rechargeable headlamp with 3-step function

ZOOM is a small, compact yet very powerful headlamp providing 220 lumen and with a remarkable low weight of only 100 g.

The beam angle can be adjusted from 10° to 60° providing a beam distance up to 80 m.

The light output is adjustable in three steps and a new feature is the »READING MODE setting«, which provides just enough light to read and enables 19 hours of operating time.

ZOOM comes in a compact design and the light can be tilted 45° to obtain the optimum lighting angle.

ZOOM
€ 29.90
03.5627



Reading mode setting
Step 1
3-STEP FUNCTION

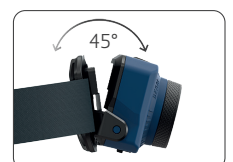

Adjustable lamp head



Adjustable beam angle 10°-60°

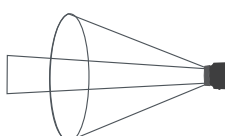

Up to 80 m





I-VIEW
€ 71.90
03.6212

NEW



**OPTI
Light**
Optimized
light and
runtime for
your work
in one touch.

EU DESIGN
PATENT
PENDING

**PRODUCT IMPROVEMENTS
COMPARED TO PREVIOUS VERSION**

- 20 % efficiency improvement
- 19 % recycled material
- OPTILight functionality
- Dedicated buttons for on/off and brightness levels
- Battery indicator
- Double temperature surveillance to protect the lamp and battery
- Min. 1000 charging cycles
- Rough service certified



// Rechargeable LED headlamp with sensor

I-VIEW is a powerful headlamp featuring OPTILight for optimized light and runtime with a simple touch. With the sensor mode, you can effortlessly control the lamp by waving a hand in front of it, even with gloves on. The lightweight and modern design includes a comfortable woven band. A user-friendly battery indicator keeps you updated on battery life, and the headlamp is designed to perform consistently in tough work environments, being both durable and resistant to water and dust (IP65).



Reading mode setting
Step 1
3-STEP FUNCTION

ZONE 2
€ 39.90
03.5850

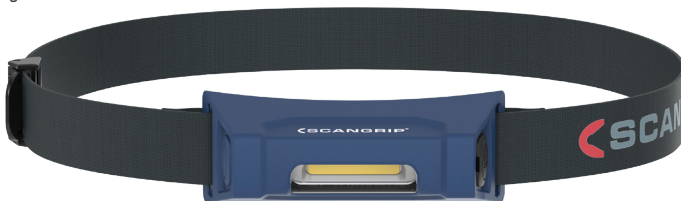

EU DESIGN
PATENT

Bracket for I-VIEW mounting

NEW

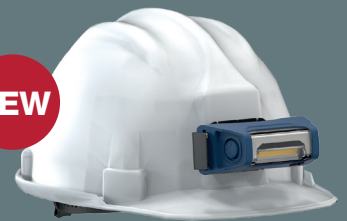

**I-VIEW
HARD HAT BRACKET**
€ 14.90
03.5797



The bracket fits 03.6212 I-VIEW headlamp

// Rechargeable ZONE 2 headlamp

The new ZONE 2 headlamp provides optimum work light illuminating the entire field of view. It is now delivering even more value for money for the professional user. The light output was increased by 33 % from 150 to 200 lumen, and with improved battery technology and now three light settings, including the new »reading mode«, the maximum operating time was increased to 22 hours. The design has become more compact, modern and user-friendly, and the new ZONE 2 also features a battery indicator and upgraded IP rating to IP54.



**I-VIEW and
ZONE 2 HEADLAMPS**



**STANDARD
HEADLAMP**



HEADLAMPS

// Compact headlamps designed for work

In almost every working situation it is convenient to have both hands free to carry out your work as efficiently as possible. The HEAD LITEs are developed to provide you with such in-dispensable and supportive bright work light.

Compared to the first generation of headlamps, the HEAD LITEs have been upgraded with the highly efficient COB LED technology that ensures optimal illumination of the work area throughout the day.

- Choose between Alkaline and rechargeable model
- Sensor function with touchless on/off switch
- Waterproof (IP54) to resist workshop environment
- High wear comfort with adjustable elastic headband



// High efficient COB LED headlamp

HEAD LITE S is a compact headlamp designed for the professional user who wants a basic headlamp that is easy to operate and applicable for all kinds of working tasks. It is supplied with a stepless dimmer function, and the lamp head is easily adjusted to obtain the optimum work lighting angle.



HEAD LITE S

€ 14.90

03.5645

Headlamp with stepless dimmer providing up to 140 lumen

Excl. batteries

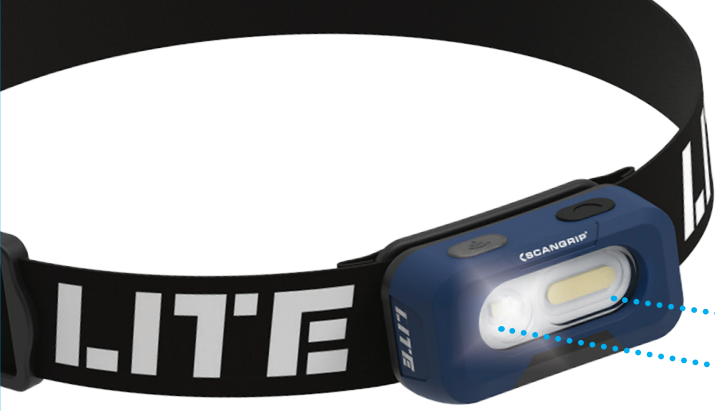

// Advanced headlamp with 2-in-1 light function

The rechargeable HEAD LITE is designed to provide optimum work light illumination with 2 different lighting functions in one: a floodlight beam angle illuminating your entire work area and a focused beam angle for inspection or long-distance use.

HEAD LITE

€ 32.90

03.5669

Rechargeable headlamp with sensor function and stepless dimmer providing up to 150 lumen

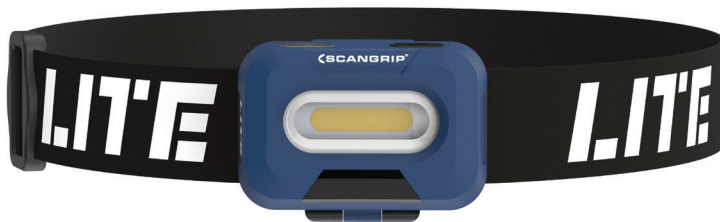

// Comfortable headlamp with batteries

HEAD LITE A is compact designed and comfortable to wear with a soft built-in protection pad to avoid imprint on the forehead. Actually, after only few minutes you will stop noticing you wear it. In spite of the small size, the light output has been improved and optimized for maximum performance, enabling the HEAD LITE A to illuminate your entire work area very efficiently. HEAD LITE A is easy to operate and applicable for all kinds of working tasks.

HEAD LITE A

€ 21.90

03.5670

Headlamp with sensor function and stepless dimmer providing up to 150 lumen

// Stepless dimmable



HEAD LITE and HEAD LITE A are upgraded with a stepless dimmer function in the range of 10 % to 100 % that enables you to easily adjust the light output to the work task.

// Touchless sensor



Both headlamps have touchless sensor function making it easy to switch on/off the lamp by just waving in front of the headlamp. In this way you can activate the lamp with thick gloves, and avoid touching the switch button with dirty hands. To avoid unintentional activation you have to activate the sensor with a dual movement.



// Flexible lighting position



The lamp head is easily adjusted to obtain the optimum work lighting angle.



STAR – work light and floodlight in one

// STAR is the missing link between a work light and a floodlight. It is a new multifunction work light that does it all!

- Extremely powerful illumination, up to 1000 lumen
 - Rechargeable up to 5 h operation time
 - Waterproof IP65
 - Ergonomic design for a comfortable, firm hand grip
 - Flexible handle for multifunctional positioning and application
 - Sturdy handle with built-in magnet
 - Direct mounting on the SCANGRIP TRIPOD
 - Durable housing made of shock-resistant plastic material
 - Built-in powerbank
- 



ORIGINAL
SCANGRIP



SINCE 1906

// Multifunctional work light

STAR is designed to be the work light that does it all. The lamp is ergonomically designed to be used as a hand held work light. Extending the position of the handle, the lamp transforms itself to be a searchlight.

// Handy floodlight

Due to the extremely powerful light output, STAR is also applicable for illumination of a larger working area, in spite of its small size compared to other floodlights. The handle is designed for direct mounting on the SCANGRIP TRIPOD.

// Flexible positioning

Due to the flexible handle the STAR can stand in different positions to obtain the optimal lighting angle for a specific work task. The handle is also clickable in fixed position to serve as a hook for suspension. Using the powerful built-in magnet in the handle the STAR can be placed in flexible positions on any metalized surface.



// Powerbank

Built-in power bank with USB outlet to charge mobile devices.



STAR
€ 99.90
03.5620



EU DESIGN
PATENT
3451038



Flexible positioning



Position the light directly on the SCANGRIP TRIPOD up to 3 m

Handheld work light



NOVA range – world's best work lights for the professional user



// SCANGRIP's NOVA work lights are well-known for their exceptional power and durability, making them the go-to choice for professionals. With universal use and sturdy design, they provide reliable lighting for a variety of tasks.

- Most sturdy and durable work lights made for ROUGH SERVICE USE
- Extremely powerful illumination, up to 12000 lumen
- Built for outdoor work
- Stands and suspensions for flexible lighting positioning





// NOVA work lights for every working situation

The NOVA range offers a wide selection of durable work lights for you to choose from. So, simply select your favourite NOVA model from the various options available. And decide whether you prefer your NOVA to be rechargeable or with a cable.

// Extreme durability

The NOVA's are designed to endure the rough, wet, and dirty conditions of the professional working environment. They are built to withstand even outdoor work in all kinds of weather conditions.

// Designed for efficient workshop use

The high efficiency multi-LED design of each NOVA work light provides a uniform and completely even illumination with colour temperature close to daylight which is particularly effective as work lighting. The light dimmer function makes it possible to adjust the light into different levels.

// Various NOVA models

Rechargeable and portable

Rechargeable with DUAL SYSTEM

With cable



1000/2000 lumen

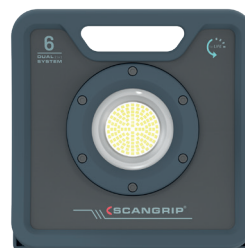

4000/6000 lumen



4000/6000/12.000 lumen

DUAL 2 in 1 SYSTEM

EU DESIGN PATENT PENDING

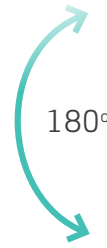

Flexible stand



OPTILight function



Durable work lights designed for ROUGH SERVICE USE

NOVA MINI – extremely compact handheld work light

// NOVA MINI stands out with its compact and versatile design. It is a preferred choice for professionals seeking portability and flexibility.

ORIGINAL
SCANGRIP
SINCE 1906



- High-efficiency multi-LED design providing 1000 lumen
- OPTILight setting for optimized light and runtime with a simple touch
- SMART GRIP 4-in-1 system for versatile use
- Resistant to water and dust with an IP65 rating

PRODUCT IMPROVEMENTS COMPARED TO PREVIOUS VERSION

- 27 % efficiency improvement
- 46 % recycled material
- OPTILight functionality
- Dedicated buttons for on/off and brightness levels
- Battery indicator
- Double temperature surveillance to protect the lamp and battery
- Min. 1000 charging cycles
- Rough service certified



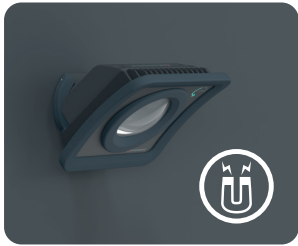

EU DESIGN
PATENT
PENDING



// Small-sized with powerful illumination

NOVA MINI is the perfect choice for professionals seeking a portable lighting solution that can easily accompany them on their tasks. Its compact design and impressive 1000 lumen output, which is exceptional for its size, make it suitable for a wide range of work applications, especially in confined spaces. With an IP65 rating, it is designed to endure demanding work environments.

// SMART GRIP 4-in-1 system

The lamp is supplied with a special, patented SMART GRIP 4-in-1 system that integrates several multi-functions in the same unit. The ring is based on the functionality you know from e.g. mobile phones which makes it easier and more convenient to keep the lamp in your hand for a long time. It relieves the muscles and increases ergonomics.

The clip is designed to fit the work belt and carry the lamp the entire day, and when both hands are needed for a task, the strong built-in magnet can be used for flexible positioning. Furthermore, SMART GRIP can be used as a stand on any available surface.



**OPTI
Light**

Optimized
light and
runtime for
your work
in one touch.

pat. pend.

**SMART
GRIP** 4 in 1



NOVA MINI

€ 74.90

03.6200



A battery indicator keeps you informed about the battery level throughout the day.

NOVA R handlamp – portable, rechargeable work light

// The handheld NOVA R work light provides powerful illumination and high flexibility – perfect to carry around from job to job.

- High-efficiency multi-LED design providing 2000 lumen
- OPTILight setting for optimized light and runtime with a simple touch
- Compact and lightweight design
- Versatile mounting options with powerful integrated magnets
- Resistant to water and dust with an IP67 rating

PRODUCT IMPROVEMENTS COMPARED TO PREVIOUS VERSION

- 13 % efficiency improvement
- 47 % recycled material
- OPTILight functionality
- Dedicated buttons for on/off and brightness levels
- Double temperature surveillance to protect the lamp and battery
- Min. 1000 charging cycles
- Rough service certified

ORIGINAL
SCANGRIP



SINCE 1906



// Portable and universal work light

The NOVA R handlamp is a universal all-around work light designed for the professional user. Featuring the latest high-performance LED technology, NOVA R provides 2000 lumen with uniform and even illumination.

NOVA R is designed to withstand tough work environments, ensuring durability and resistance to water and dust (IP67). The adjustable light output gives you control over the illumination, while the separate indicators for runtime and battery life allow for easy monitoring of operating time and remaining battery power.



EU DESIGN
PATENT
PENDING

// Multifunctional design for high flexibility

NOVA R is easy to carry and is ergonomically designed for a good grip on the handle, which is also equipped with powerful integrated magnets for flexible mounting. Due to the flexible handle, NOVA R can be placed in different positions to obtain the desired lighting angle. The handle is also designed for direct mounting on the TRIPOD or the SCAFFOLDING BRACKET.



NOVA R
€104.90
03.6201

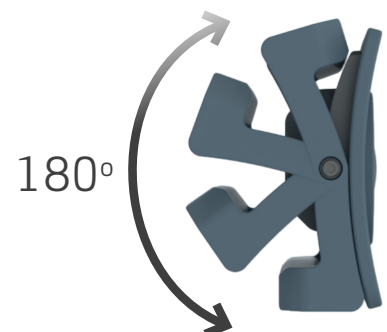

NOVA - extremely durable work lights built for rough and demanding work environments

// Universal and powerful work lights for the most challenging lighting operations in every rough and demanding work environment.

- Portable LED work lights with versatile design for easy transportation
- High-efficiency multi-LED design
- OPTILight setting for optimized light and runtime in a simple touch
- Water and dust-resistant (IP67)
- Accessories - compatible with a variety of accessories to enhance functionality

Rechargeable NOVAs

PRODUCT IMPROVEMENTS COMPARED TO PREVIOUS VERSIONS

- Up to 14 % efficiency improvement
- OPTILight functionality
- Dedicated buttons for on/off and brightness levels
- Easier cable connectivity and improved bracket design
- Double temperature surveillance to protect the lamp and battery
- Min. 1000 charging cycles
- Rough service certified

NOVAs with cable

PRODUCT IMPROVEMENTS COMPARED TO PREVIOUS VERSIONS

- Up to 6 % efficiency improvement
- OPTILight functionality
- Dedicated buttons for on/off and brightness levels
- Temperature surveillance to protect the lamp
- Rough service certified



ORIGINAL
SCANGRIP



SINCE 1906

// Designed for efficient workshop use

The iconic design of the NOVA work lights features an integrated carrying handle and a flexible stand, allowing for easy transportation and quick adjustments in lighting angles. The stand is designed for direct mounting on the SCANGRIP TRIPOD, offering versatile placement options.

When transitioning between tasks or working on a large-scale project, the user-friendly design makes it easy to set up the ideal lighting conditions, thus enhancing efficiency.

// Rechargeable NOVAs

C+R stands for cable and rechargeable and is a unique DUAL SYSTEM that makes it possible to use the work light with a 5 m rubber power cable or simply without the cable. It only takes a second to connect the power cable or disconnect it when a cordless work light is needed, providing greater flexibility on the worksite. rechargeable versions are also supplied with a user-friendly display showing both battery capacity and the remaining operating time.

EU DESIGN
PATENT
PENDING



NOVA 4 C+R
€ 214.90
03.6204
Durable rechargeable LED work light providing 4000 lumen. 44 % recycled material.
DUAL 2 in 1 SYSTEM



NOVA 6 C+R
€ 254.90
03.6205
Durable rechargeable LED work light providing 6000 lumen. 47 % recycled material.
DUAL 2 in 1 SYSTEM

// NOVAs with cable

The NOVA range offers 3 cabled models, all providing extremely powerful illumination. With a light output of 12000 lumen, NOVA 12 is designed for the most challenging lighting operations. With the integrated BLUETOOTH light control feature you can easily control up to four work lights. The light control also makes it possible to turn on/off the lamp and adjust the light output to suit the work task in question. The BLUETOOTH application is perfect when working with one or more hard-to-reach lamps, for example positioned on the SCANGRIP TRIPOD.



NOVA 4
€ 134.90
03.6202

Durable LED work light with 5 m cable providing 4000 lumen. 40 % recycled material.



NOVA 6
€ 154.90
03.6203

Durable LED work light with 5 m cable providing 6000 lumen. 47 % recycled material.



NOVA 12
€ 284.90
03.6206

 Durable LED work light with BLUETOOTH and 5 m cable providing 12000 lumen. 52 % recycled material.

LIGHT CONTROL



 **Bluetooth**[®]

VEGA LITE - a range of LED floodlights

ORIGINAL
SCANGRIP
SINCE 1906

// Innovative, high performance work lights

The VEGA LITE range consists of 4 high quality floodlights in cool design offering very powerful illumination at an attractive price.

- Powerful, diffused, non-blinding illumination
- Durable housing made of highly shock-resistant plastic material
- Rechargeable and cabled versions available
- For indoor as well as outdoor use
- No fire hazard due to minimum heat production

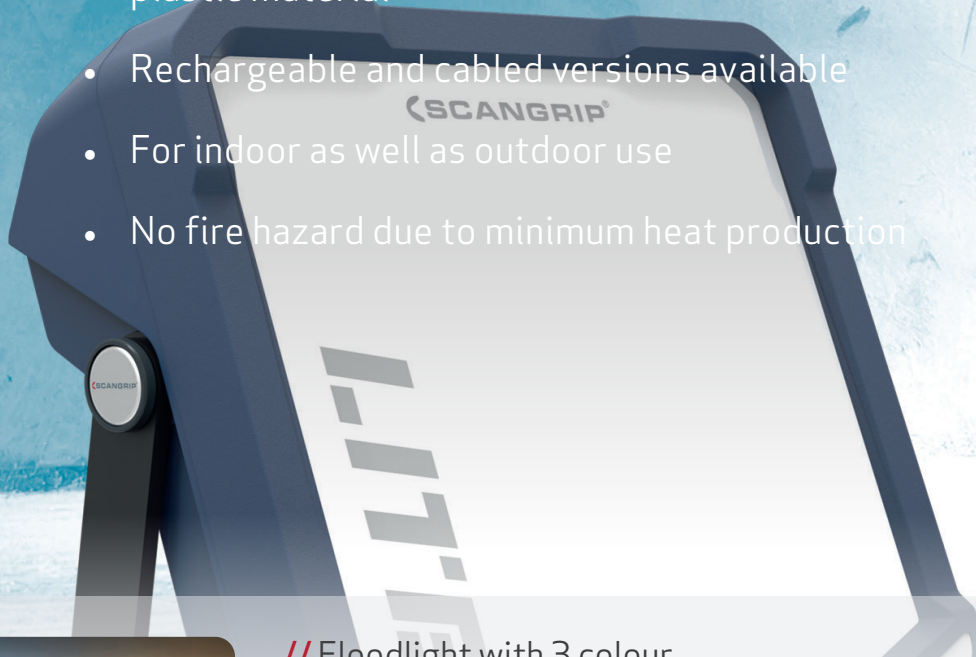

// Floodlight with 3 colour temperature settings

VEGA LITE COLOUR is developed especially for house painters and other professional craftsmen working on surface preparation, such as filling, wallpapering, and sanding.

It provides 5000 lumen and features 3 different colour temperature settings including warm (2500 Kelvin), medium (4500 Kelvin), and cold light (6500 Kelvin). Select exactly the colour temperature that suits the work situation best. This functionality is also useful for other indoor tasks, like setting up tiles, ceilings, floors, etc. in the construction industry.



VEGA LITE COLOUR

€ 179.90

03.5459

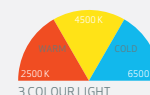

2 power outlets



Floodlight with 3 colour temperature settings providing 5000 lumen. With 2 power outlets

// Powerful, diffused LED light

The many powerful LEDs of the VEGA LITE floodlights provide a diffused and pleasant, non-blinding, uniform work light, with a large dispersion. The entire range has been upgraded and now provides even more lumen than the previous versions.

// Designed for professionals

The lightweight, sturdy and durable housing of the VEGA LITEs is made of a highly shock-resistant plastic material, constructed for use in the demanding working environment. Contrary to traditional halogen work lights heat production is minimal avoiding fire hazard. The stand is made of powder coated steel and can be mounted directly on the SCANGRIP TRIPOD.

// Unique functionality

The VEGA LITE C+R is with the unique DUAL SYSTEM which means **both** rechargeable **and** with 5 m cable providing complete flexibility and unlimited application possibilities.

// Power outlet

Both the new VEGA LITE COMPACT, VEGA LITE and VEGA LITE COLOUR floodlights are born with power outlet which offers additional functionality in daily use as more lamps can be connected in a string. Also, the outlet can be used as power source for tools and machinery.

DUAL 2 in 1 SYSTEM



EU DESIGN PATENT 2954123



VEGA LITE provides 6000 lumen and is designed for "rough-service-use" with 2 power outlets on the back

DUAL 2 in 1 SYSTEM



VEGA LITE C+R

€134.90

03.5451

Floodlight with DUAL SYSTEM providing up to 2500 lumen



VEGA LITE COMPACT

€134.90

03.5673

Floodlight with 3 m cable and 1 power outlet providing 4000 lumen



VEGA LITE

€154.90

03.5453

Floodlight with 5 m cable and 2 power outlets providing 6000 lumen

AREA LITE CO

// 360° high performance LED work light

- A must-have universal light for any working site
- Illuminates the entire room and working area
- Powerful, diffused, non-blinding illumination
- Durable housing made of highly shock-resistant plastic material

ORIGINAL
SCANGRIP
SINCE 1906



// Illuminating the entire working area

The AREA LITE CO is a real basic work light especially designed to illuminate the entire room 360° around. The AREA LITE CO provides a diffused and pleasant, non-blinding, and uniform work light with large dispersion. These features are ideal for the demanding craftsman who requires powerful and efficient illumination of not only larger surfaces but the entire room carrying out any kind of repair, paint or construction work.

// Powerful 360° work light

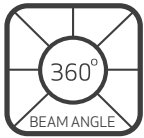

The light output of the upgraded AREA LITE CO has been increased from 4000 lumen to 6000 lumen which is very powerful compared to similar lamps on the market. AREA LITE CO is extremely sturdy and durable and withstands being dropped.

// Flexible positioning

The AREA LITE CO can be positioned directly on the workbench or hang in the sturdy hook from any mounting option available. SCANGRIP mounting stands offer completely flexible lighting solutions; the lamp can be mounted directly onto the TRIPOD without any time spent on fastening obtaining a height of up to 3 m. If you need a mobile light that can be moved quickly from place to place the lamp can be mounted directly on the WHEEL STAND.

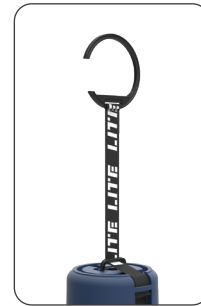

EU DESIGN
PATENT
4070035

Strong built-in nylon strap with hook for suspension. The strap is also designed as a practical carrying strap



AREA LITE CO

€ 164.90

03.5637

360° work light with 5 m cable and power outlet providing 6000 lumen

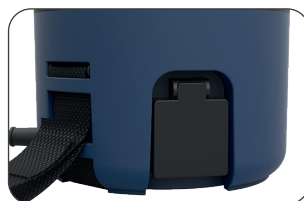

More lamps can be connected in a string by the power outlet of the AREA LITE CO and can also be used as power source for various tools and machinery.



STANDS and SUSPENSIONS

// Designed for direct mounting of work lights without bracket. Made of durable and sturdy powder coated steel for both indoor and outdoor use.

// High stability tripod

The SCANGRIP TRIPOD is indispensable for stationary positioning of the work light for illumination in a specific working area. The SCANGRIP TRIPOD is extendable from only 1.35 m up to 3 m which gives you complete flexibility to position the light in the requested height.

The stable construction of the SCANGRIP TRIPOD 3M makes it safe even when fully extended. It is supplied with anchor points that provide an opportunity for extra stability if the tripod is exposed to strong wind or standing on an uneven surface. To increase safety when in use, the cable of the lamp can be fixed in the safety clips placed on each separate leg.

// Lightweight TRIPOD with QUICK RELEASE function



With its lightweight and extremely handy design, the SCANGRIP TRIPOD 2M is indispensable for stationary positioning of the work light for illumination in a specific working area. The tripod is extendable from 0.9 meter up to 2 meters, which gives you complete flexibility to position the light in the requested height. When mounted on the tripod the light can be tilted to provide the optimum beam angle.

Featuring a compact design and QUICK RELEASE function, it is easy and convenient to carry the tripod and set it up where illumination is needed. The tripod is extremely durable and can be applied for both indoor and outdoor use. The stable construction makes it safe even when fully extended. It is made of black painted aluminum.

QUICK RELEASE function



Welded steel mounting cap 10 mm thread

SCANGRIP TRIPOD 3M

€ 129.90

03.5431

6 kg
Max load 10 kg

360° locking system for a firm grip

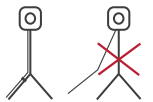
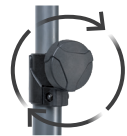

SCANGRIP TRIPOD 2M

€ 89.90

03.5685

2.1 kg
Max load 5 kg



Lightweight
Easy to carry

DUAL BRACKET not applicable.

// Wheel stand for mobile positioning

The SCANGRIP WHEEL STAND makes it easy to move the light to where you need it, and at the same time you avoid uncomfortable and heavy lifting from one workplace to the other. It is upgraded with a new base which is equipped with 5 wheels for improved safety and stability and easy maneuverability.



As an additional feature, it now comes with a flexible bracket that enables you to easily position a second work light to illuminate from below. The extra mounting bracket is adjustable in the height and provides complete flexibility to position the light in the optimum height.



Up to 1.9 m

WHEEL STAND

€ 169.90

03.5682

6.6 kg
Max load 10 kg



// Suspensions for flexible positioning

DUAL BRACKET

€ 29.90

03.5308



Dual bracket for positioning of two lamps on TRIPOD or WHEEL STAND

SCAFFOLDING BRACKET

€ 34.90

03.5341



For flexible positioning on scaffoldings or any round object ø40-50 mm



MAGNET BRACKET

€ 31.90

03.5390



For flexible positioning of the work light on any magnetic surface

MAGNET BRACKET - Large

€ 54.90

03.5391



// SCANGRIP DIFFUSER provides a large dispersion and spreads the light

Enlightens the entire working area, even into the darkest corner and softens the light avoiding hard shadows. Minimizes reflections and harsh light and provides non-blinding work light.



Easy and safe mounting with strong magnets

SCANGRIP DIFFUSER

€ 10.90

03.5750



SCANGRIP DIFFUSER - Large

€ 15.90

03.5751



SCANGRIP DIFFUSER - Medium

€ 8.90

03.5922



SCANGRIP DIFFUSER - X-Large

€ 19.90

03.5951



NEW



SCANGRIP DIFFUSER - XX-Large

€ 24.90

03.5952



NEW



For compatibility, please refer to scangrip.com

SITE LIGHT – high-performance construction site lights

// SCANGRIP presents new, powerful SITE LIGHT work lights that are made in Denmark and provide extremely high light output at a very attractive price.

The SITE LIGHTs feature active cooling and have a long lifetime. Available in two variants providing 40.000 lumen and 80.000 lumen.

- Powerful illumination with wide beam angle
- Light dimmable in 4 steps
- BLUETOOTH light control
- Compact and low weight
- Waterproof (IP65) for all kinds of outdoor weather conditions



SITE LIGHT 80

€ 1069.90

03.5269

 Large area light with BLUETOOTH and dimmer function providing up to 80.000 lumen

SITE LIGHT 40

€ 669.90

03.5268

 Large area light with BLUETOOTH and dimmer function providing up to 40.000 lumen

ORIGINAL
SCANGRIP



SINCE 1906

MADE IN DENMARK



EU DESIGN
PATENT
7180187

Bluetooth®

BLUETOOTH - Light control app

- Dimmer light output into 4 levels
- Switch on/off
- Group control function, up to 4 lamps
- Assign pin code



Compliant with iPhone 5 or higher/Android 5.0 or higher. Go to iTunes App Store to download the app or download the app from scangrip.com

// Powerful illumination and BLUETOOTH light control

Based on the newest state-of-the-art LED technology, the SITE LIGHTs provide an extremely high light output and a wide 120° beam angle, ensuring super bright illumination of a large work area. The dimmer function enables you to adjust the light in four different levels, and by using the BLUETOOTH light control app, you can turn on/off the work light and adjust the light remotely through your mobile device. When the work lights are mounted on high masts, this feature reduces the power consumption on an everyday basis as you only use the amount of light necessary to do the job.

// Compact design for easy mounting



The SITE LIGHTs are designed with a built-in handle for easy carrying and mounting on tripod and masts. They are extremely compact and low weight compared to other solutions on the market, which makes the mounting of the work lights more convenient. The SITE LIGHTs come with

10-meter cable and include a DIN14640 connection adapter with bracket for mounting on a tripod.

// Built to do the job at the construction site

The SITE LIGHTs are completely dust and waterproof (IP65) and tolerate all kinds of weather conditions from -25 to +40 °C. Featuring high-quality components and active cooling, the work lights have a long lifetime and keep a high performance level throughout the day.



**TRANSPORT CASE
SITE LIGHT 80**

€ 171.90

49.0351

**TRANSPORT CASE
SITE LIGHT 40**

€ 96.90

49.0350

The transport cases enable you to safely transport your SITE LIGHT work light to the building site. They are sturdy and high-quality cases that can withstand shocks and rough handling during transport.

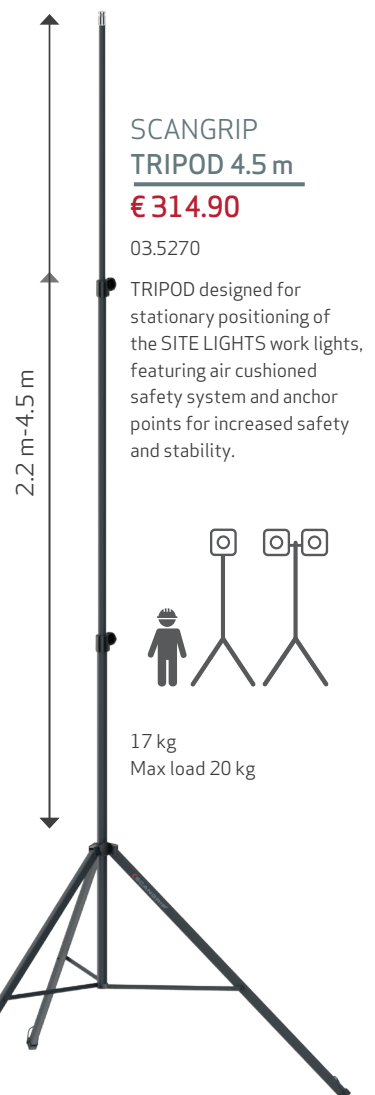

**SCANGRIP
TRIPOD 4.5 m**

€ 314.90

03.5270

TRIPOD designed for stationary positioning of the SITE LIGHTs work lights, featuring air cushioned safety system and anchor points for increased safety and stability.

17 kg
Max load 20 kg

**DUAL BRACKET
SITE LIGHT**

€ 59.90

03.5758



Dual bracket for positioning of two SITE LIGHTs

ROPE LIGHT - 25 m flexible rope light providing 20.000 lumen



// Illuminate your surroundings and stay safe on the worksite with a practical and legal rope light.

- EMC certified rope light with built-in power supply
- Maximum safety with low voltage (48 V DC)
- No risk of electrical shock
- Made of durable and heat-resistant silicone





// Maximum safety

ROPE LIGHT runs on low voltage (48 V DC), which means that there is no risk of electrical shock if the rope should be accidentally pinched or cut. This distinguishes ROPE LIGHT from all other rope lights on the market, which use 230 V power directly connected with the risk of fatal shocks. Only light ropes operated through a power supply are legal. ROPE LIGHT is made of heat resistant silicone and fully flexible, even in extreme cold down to -20 °C. With IP65, the rope light is suitable for use in humid working environments.

ROPE LIGHT is flicker-free, which means that there is no annoying flicker effect that can be a nuisance during the work and, in the worst case, cause misjudgment of rotating tools. ROPE LIGHT is EMC certified and in compliance with all applicable legislation in the area (EMC directive 2014/30/EU).

// Easy and convenient connection

ROPE LIGHT is delivered on an impact-resistant drum with a practical carrying handle. The power supply is built-in with a fixed 1.5 m connection cable, making it easy to connect to a standard power socket. To avoid overheating, always unwind the light rope completely from the drum before connecting the power. For convenient storage, the power cable can be wrapped around the drum under the light rope when not in use.



Durable silicone bendable down to -20 °C and passed 650 °C glow-wire testing



High IP for use in moist environment



Flicker free



ROPE LIGHT

€ 399.90

03.5815

25 m flexible rope light providing 20.000 lumen



Built-in power supply with over-temperature protection and 1.5 m cable



FLEX WEAR – flexible work light designed to wear

// Indispensable little companion you can take with you everywhere

FLEX WEAR is a small wearable flexible work light designed with a 2-step main light providing as much as 150 lumen and a spotlight providing 75 lumen. It increases safety and working comfort making you visible moving around and providing light to illuminate your workspace. It can also be used as a pocket light with the built-in clip, as an inspection light or positioned fixed with the built-in magnet. The design of FLEX WEAR is smooth, compact and lightweight, only 42 g.



FLEX WEAR

€ 30.90

03.5810



Use as flashlight



Built-in magnet



Clip onto your clothes

// FLEX WEAR including headband and cap mount

With the accessories included in the FLEX WEAR KIT it can be used as a headlamp or mounted on a cap. Use the spotlight for a long-distance light wearing it on the side of your head. Fixed on the headband or cap mount FLEX WEAR provides total flexibility to obtain the best possible lighting angle since it can be turned 360° around both axes.

- Clip onto your cap
- Use as a headlamp
- Clip onto your clothes
- Use as a flashlight

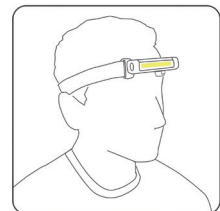

FLEX WEAR KIT

€ 41.90

03.5811

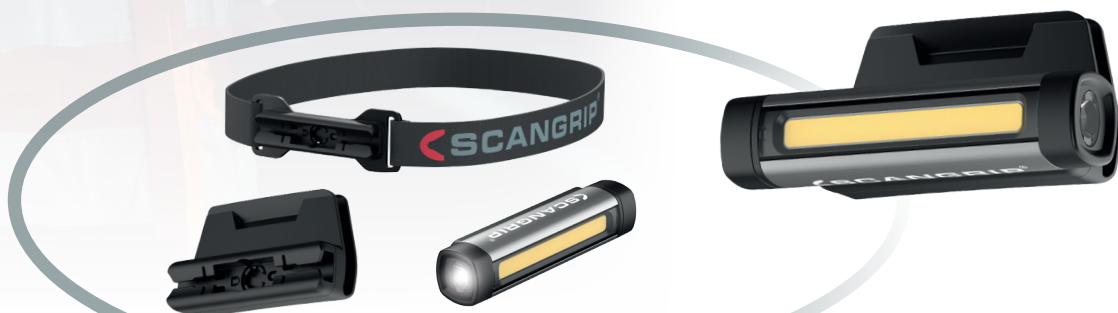

FLEX WEAR is 100 % flexible work light with numerous areas of application. Use it exactly where you want: in your chest or pant pocket with the built-in clip, on your cap with the special mounting device or use it as headlamp mounted on the headband. FLEX WEAR can also be used as a flashlight for inspection or positioned and fixed with the built-in magnet to illuminate your work area.

ORIGINAL
SCANGRIP



SINCE 1906

FLASHLIGHT *series*

// SCANGRIP provides the strongest and most comprehensive range of LED work lights on the market. We are now proud to present an upgraded and re-designed flashlight series providing extremely high light output and improved functionality for an even better user experience.

The new flashlights are available both as rechargeable and with batteries, providing brand-new features and accessories to increase work efficiency.

- BOOST MODE
- Practical clip-on holster for the work belt
- One-hand operated magnetic switch
- Higher lumen output
- Long operation time

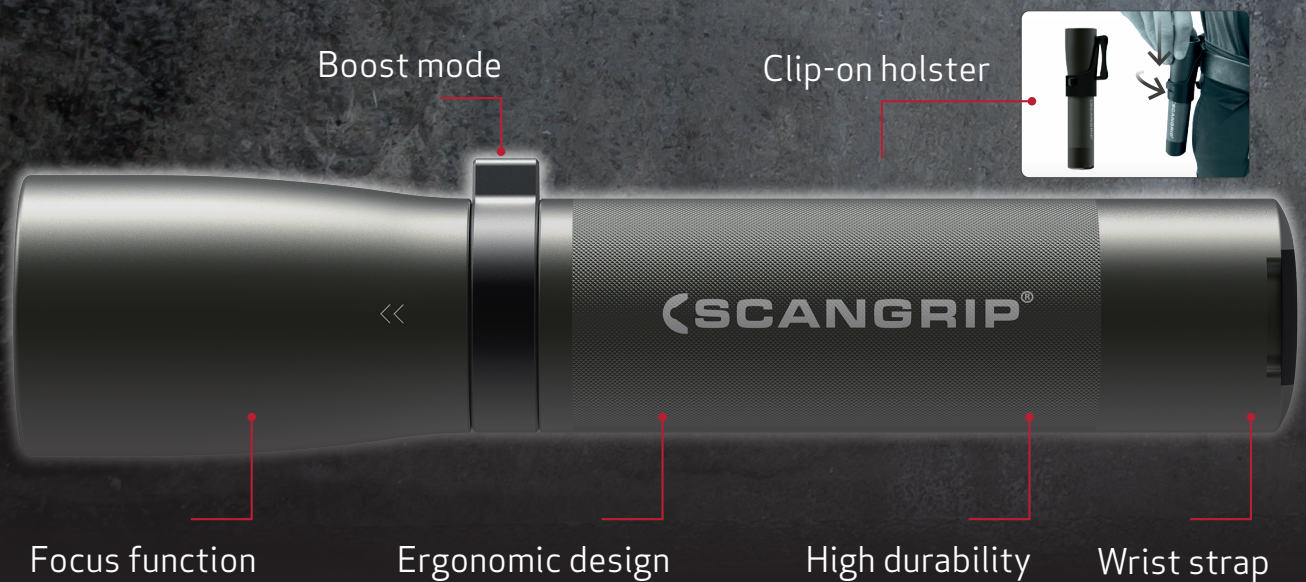

Boost mode

Clip-on holster

Focus function

Ergonomic design

High durability

Wrist strap

FLASH series with batteries

// The new durable flashlight series with Alkaline batteries is designed for the rough and demanding work environment providing high-quality flashlights for all types of inspection tasks.

EU DESIGN
PATENT
7180187

Dimmable keychain light with integrated USB charger cable

Ultra-compact and bright LED keychain light that provides up to 75 lumen.

FLASH MICRO R

€ 14.90

03.5113



FLASH MICRO R comes in a display of 12 pcs.



Power bank with battery indicator

The power bank can be used for recharging your SCANGRIP work light as well as other devices. Featuring battery indicator and intelligent load detection. Modern and durable design.

SCANGRIP POWER BANK

€ 34.90

03.5782

4000 mAh aluminum power bank

The new ultra-slim FLASH PENCIL

A must-have for everybody doing daily inspection tasks. It is so thin, only $\varnothing 15$ mm. Supplied with a clip and designed to always have in the chest pocket, right at your fingertips.

Weighing only 32 g the FLASH PENCIL is incredibly lightweight.

FLASH PENCIL

€ 19.90

03.5130

Ultra-slim pencil flashlight providing 75 lumen

FLASH PEN

€ 27.90

03.5131

Pencil flashlight with boost mode providing up to 200 lumen

FLASH 300

€ 34.90

03.5132

Flashlight with boost mode providing up to 300 lumen
Incl. silicone wrist strap and clip-on holster

FLASH 600

€ 44.90

03.5133

Flashlight with boost mode providing up to 600 lumen
Incl. silicone wrist strap and clip-on holster



Rechargeable FLASH R series

// Sturdy and powerful flashlights of extraordinary high quality providing extremely bright illumination and durability. Easily recharged by the enclosed USB cable.

The new WORK PEN 200 R is a real work light for professional inspection work. It is extremely powerful for its small size. Supplied with a clip for the chest pocket and built-in magnets for flexible positioning.

EU DESIGN
PATENT
7180187



MINI LITE A

€ 8.90

03.5102

Small pocket-sized flashlight with keychain providing 100 lumen



FLASH 1000 R

€ 69.90

03.5138

Rechargeable flashlight with boost mode providing up to 1.000 lumen
Incl. silicone wrist strap and clip-on holster



FLASH 600 R

€ 59.90

03.5137

Rechargeable flashlight with boost mode providing up to 600 lumen
Incl. silicone wrist strap and clip-on holster



FLASH PEN R

€ 39.90

03.5136

Rechargeable pencil flashlight with boost mode providing up to 300 lumen



WORK PEN 200 R

€ 29.90

03.5127

Rechargeable LED penlight providing up to 200 lumen



Pocket sized FLASH 12-24V

With a new brushed-up look, the FLASH 12-24V is designed to easily charging directly from the cigarette lighter socket in your car. No need of charger device, cable, or batteries!

FLASH 12-24V

€ 29.90

03.5124

Rechargeable flashlight providing 130 lumen



LINE LIGHT - *unique lighting concept*

// LINE LIGHT is a flexible lighting solution for universal application designed for use anywhere where strong, efficient and concentrated light in a specific working area is needed. Now in a new upgraded version with double lumen output.

- Most competitive solution on the market
- “Unbreakable” - extremely sturdy and shockproof
- Waterproof to resist wet and dirty workshop environment
- Low voltage 24 V DC
- Technical lifetime of LEDs 100.000 hours
- Made in Denmark



ORIGINAL
SCANGRIP



SINCE 1906

MADE IN DENMARK

// Bright illumination exactly where you need it

By means of a built-in prism, LINE LIGHT concentrates the light in a 75° beam angle providing an extremely bright and powerful illumination of the specific working area. Blinding during work is avoided, and the lamp itself can be turned to provide the optimum lighting angle.

// Innovative LED technology

The LINE LIGHT series is based on the newest state-of-the-art LED technology and provides much more light compared to the traditional 36 W fluorescent tubes which are commonly used within the industry.

The quality of the light is extremely powerful, like daylight which is optimum for precise recognition of colours, shades and other product details. The uniform, flicker free illumination without strobe effects also minimizes the risk of accidents.

// Extreme durability

LINE LIGHT is constructed by a closed "unbreakable" extruded acrylic profile which makes it extremely sturdy and shockproof to endure even strong strokes, shocks and vibrations from industrial machinery.

LINE LIGHT endures the rough, wet and dirty conditions of the professional working environment within the industry and is resistant to both oil and chemicals. The IP67 classification means that it is resistant to both dust and water. LINE LIGHT is completely maintenance free.

// Reduced power consumption

Compared to traditional fluorescent tube lighting, the electricity consumption is considerably reduced when using LINE LIGHT which presents serious cost savings on electricity.



// Dimmer

With the dimmer function it is possible to adjust the light intensity stepless from 1-100 % to meet individual working conditions. LINE LIGHT 2-POST and LINE LIGHT 4 are delivered incl. dimmer, and can also be bought separately and retrofitted on all existing LINE LIGHT installations.

BEAM
ANGLE
75°



IP67



ULTRA
SLIM
DESIGN
Ø25 mm

EU DESIGN
PATENT
1882523



FLEXIBLE lighting solution for 2-post lifts and mobile column lifts

ORIGINAL
SCANGRIP
SINCE 1906
MADE IN DENMARK

LINE LIGHT 2-POST is a universal all-in-one solution always available at hand and ready to use when needed.

The lighting unit can be positioned everywhere underneath the car with magnets and can be moved under the car to the actual repair work.

Due to the 5 m spiral cable, the lamp can easily be used for illumination around the entire car, or as a dedicated lamp for engine bay or wheel arch illumination.

- Fits all 2-post lifts and mobile column lifts regardless of type
- Powerful illumination providing 2 x 1250 lumen
- Easy and uncomplicated to mount
- No drilling in the lift construction
- Incl. DIMMER function

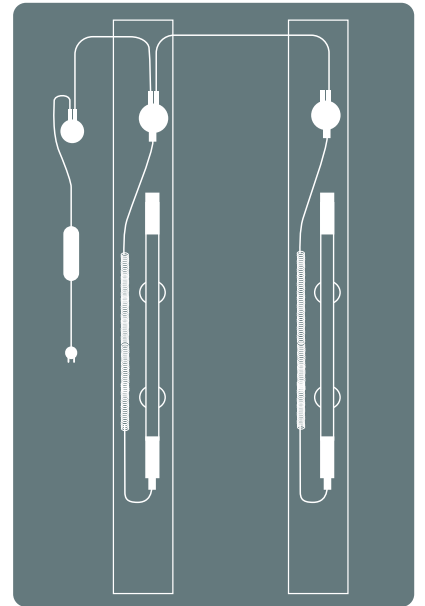

LINE LIGHT 2-POST

€ 403.90

03.5225



FLEXIBLE MAGNETIC SUSPENSION



COMPLETE lighting solution for automotive lifts

- Extremely powerful illumination of working area - improved lumen output
- Improve work efficiency and working conditions
- Avoid blinding the mechanic during work
- Adjustable lighting angle

// Compact design

Compared to traditional 36 W fluorescent tubes, LINE LIGHT provides an extremely bright and powerful illumination of the entire undercarriage. The slim and compact design leaves space for the center jack to pass.

// Easy DIY installation

As LINE LIGHT is a low operating voltage (24 V DC) system, you can easily do the installation yourself. All basic fittings are supplied with each kit together with power supply and cable. The pre-defined LINE LIGHT kits are considered universal and will fit the majority of all automotive 4-post lifts, regardless of the manufacturer or brand.



BEAM ANGLE
75°



Blinding of the mechanic during work is avoided, and the lamp itself can be turned to provide the optimum lighting angle during work.



Example of LINE LIGHT solution mounted in a truck mechanic's pit

LINE LIGHT 1

€ 241.90

03.5203

1 complete lighting unit 1630 mm incl. 25 W power supply, cable and suspension providing 2750 lumen

LINE LIGHT 2

€ 393.90

03.5202

2 complete lighting units 1234 mm each providing 2000 lumen, incl. 80 W power supply, cable and suspension

LINE LIGHT 4

€ 1009.90

03.5201

4 complete lighting unit 1630 mm each providing 2750 lumen, incl. 80 W power supply, cable, suspension and dimmer function

LINE LIGHT 6

€ 1514.90

03.5200

6 complete lighting units 1630 mm each providing 2750 lumen, incl. 2 pcs 80 W power supply, cable and suspension

FLEXIBLE lighting units for customized installations

The LINE LIGHT lighting units are available in different lengths which can either be used alone or connected in a string to fit all kinds of application.

The lighting units can be combined exactly the way you want offering a flexible lighting solution.

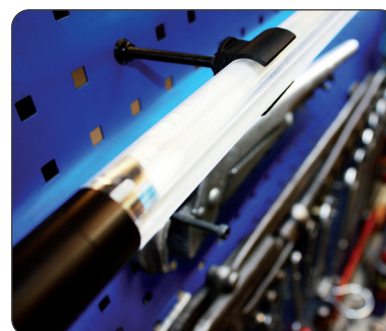
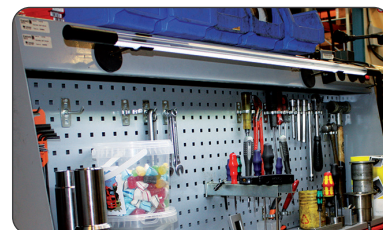
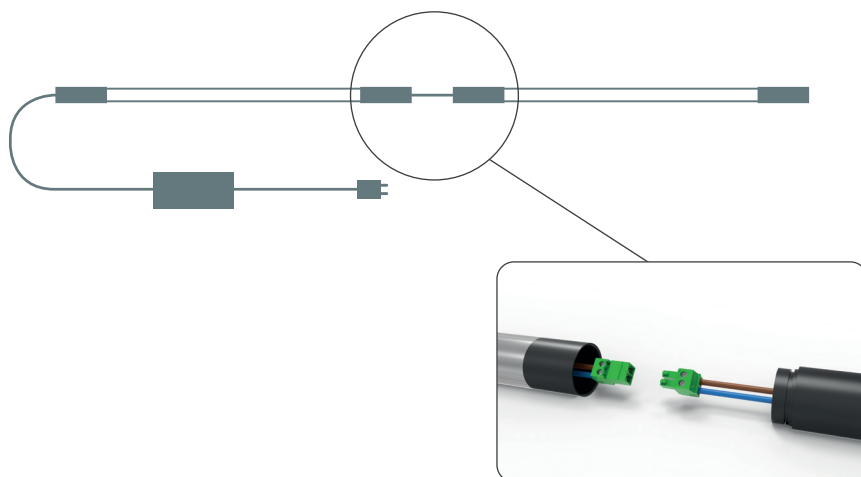

// Flexibility that meets your specific needs

Combine lighting units with power supply, cable and suitable suspensions. A range of flexible suspensions makes it possible to position the lighting units exactly where you need it.

DESIGN YOURSELF



LINE LIGHT 75

€ 120.90

03.5221

Lighting unit 838 mm
providing 1250 lumen



LINE LIGHT 120

€ 201.90

03.5222

Lighting unit 1234 mm
providing 2000 lumen



LINE LIGHT 160

€ 231.90

03.5223

Lighting unit 1630 mm
providing 2750 lumen



LINE LIGHT 200

€ 272.90

03.5224

Lighting unit 2027 mm
providing 3500 lumen



MAG series

	MAG PEN 3	MINI MAG PRO	MAG	MAG PRO
Product number	03.5116	03.5692	03.5400	03.5690
Light source	COB LED Spot: CREE XP-G2	COB LED Spot: High power LED	10 SMD LEDs Spot: High power LED	COB LED Spot: High power LED
Luminous flux, lumen	15-150 Spot: 80	20-200 Spot: 80	150-300 Spot: 80	60-600 Spot: 150
Adjustable light output	Stepless	Stepless	2 levels	Stepless
CRI	Ra > 80	Ra > 80	Ra > 80	Ra > 80
CCT	6000 K	6000 K	6000 K	6000 K
Operating time with max. lumen, h	2	2	2.5	1.5
Operating time with min. lumen, h	20	20	5	15
Charging time, h	3.5	3	4	4
Battery	3.7 V/750 mAh Li-ion	3.7 V/1200 mAh Li-ion	3.7 V/2200 mAh Li-ion	3.7 V/2600 mAh Li-ion
Protection class	IP20	IP54	IP20	IP54
Impact protection	IK07	IK07	IK07	IK07
Impact resistance	1 m	1 m	1 m	1 m
Cable	1 m USB	1 m USB	1 m USB	1 m USB
Operating voltage AC	-	-	-	-
Charging voltage/current DC	5 V/1 A	5 V/1 A	5 V/1 A	5 V/1 A
Power consumption	Max 2.5 W	Max 2.5 W	Max 3.5 W	Max 6.5 W
Charger incl.	No	No	Country-specific	Country-specific
Temperature	-10 to +40 °C	-10 to +40 °C	-10 to +40 °C	-10 to +40 °C
Dimensions	174 x 31 x 21 mm	200 x 40 x 28 mm	260 x 61 x 43 mm	261 x 62 x 43 mm
Net weight	78 g	157 g	252 g	339 g
Price	€ 37.90	€ 42.90	€ 52.90	€ 64.90

UNIFORM series

	NEW UNIPEN	NEW MINIFORM	NEW UNIFORM
Product number	03.6209	03.6207	03.6208
Light source	High efficiency multi-LED design with 20 LEDs	High efficiency multi-LED design with 20 LEDs	High efficiency multi-LED design with 32 LEDs
Luminous flux, lumen	15-150 Spot: 75	20-200 Spot: 120	50-500 Spot: 175
OPTILight setting	500 lux@0.25 m	500 lux@0.25 m	500 lux@0.5 m
Adjustable light output	3 levels	3 levels	3 levels
Beam angle	100° Spot: 50°	115° Spot: 35°	110° Spot: 30°
CRI	Ra > 80	Ra > 80	Ra > 80
CCT	5700 K	5700 K	5700 K
Operating time max./min. lumen, h	3/22	3/27	3/32
Operating time OPTILight, h	5.5	7	4
Charging time, h	2.5	3	3.5
Battery	3.7 V/800 mAh Li-ion	3.7 V/1010 mAh Li-ion	3.7 V/2600 mAh Li-ion
Verified no. of charging cycles	Min. 1000	Min. 1000	Min. 1000
Protection class	IP65	IP65	IP65
Rough service	Yes	Yes	Yes
Impact protection	IK07	IK07	IK07
Impact resistance	2 m	2 m	2 m
Cable	1 m USB-A to USB-C	1 m USB-A to USB-C	1 m USB-A to USB-C
Operating voltage AC	-	-	-
Charging voltage/current DC	5 V/1 A	5 V/1 A	5 V/1 A
Power consumption	1.1 W	1.2 W	3.2 W
Charger incl.	No	No	No
Operating temperature	-10 to +40 °C	-10 to +40 °C	-10 to +40 °C
Dimensions	158 x 27 x 21 mm	126 x 60 x 23.5 mm	188 x 60 x 33 mm
Net weight	77 g	106 g	263 g
Price	€ 45.90	€ 56.90	€ 89.90



MAG series



	MAG PRO WIRELESS	CHARGING PAD
Product number	03.5691	03.5928
Light source	COB LED Spot: High power LED	-
Luminous flux, lumen	60-600 Spot: 150	-
Adjustable light output	Stepless	-
CRI	Ra > 80	-
CCT	6000 K	-
Operating time with max. lumen, h	1.5	-
Operating time with min. lumen, h	15	-
Charging time, h	USB: 4 h - Wireless: 7 h	-
Battery	3.7 V/2600 mAh Li-ion	-
Protection class	IP54	IP30
Impact protection	IK07	IK07
Impact resistance	1 m	1 m
Cable	1 m USB	USB (excl.)
Charger voltage	-	100-240 V AC 50/60 Hz
Charging voltage/current DC	5 V/1 A	5 V/DC 1 A
Power consumption	Max 6.5 W	Max 5 W
Charger incl.	-	-
Temperature	-10 to +40 °C	-10 to +40 °C
Dimensions	261 x 62 x 43 mm	183 x 84 x 13 mm
Net weight	339 g	115 g
Price	€ 74.90	€ 29.90

POWER BANK		Product number	Price
	POWER BANK with 4000 mAh aluminum battery and spiral cable. 5 V/2 A. Ø28 x 103 mm. 130 g	03.5782	€ 34.90

SLIM series



	NEW MINI SLIM	NEW SLIM
Product number	03.6210	03.6211
Light source	High efficiency multi-LED design with 16 LEDs	High efficiency multi-LED design with 20 LEDs
Luminous flux, lumen	20-200 Spot: 100	50-500 Spot: 150
OPTILight setting	500 lux@0.25 m	500 lux@0.5 m
Adjustable light output	3 levels	3 levels
Beam angle	110° Spot: 25°	110° Spot: 25°
CRI	Ra > 80	Ra > 80
CCT	5700 K	5700 K
Operating time max./min. lumen, h	2/19	2.5/27
Operating time OPTILight, h	5.5	4
Charging time, h	2.5	3.5
Battery	3.7 V/800 mAh Li-ion	3.7 V/2600 mAh Li-ion
Verified no. of charging cycles	Min. 1000	Min. 1000
Protection class	IP30	IP30
Rough service	-	-
Impact protection	IK07	IK07
Impact resistance	2 m	2 m
Cable	1 m USB-A to USB-C	1 m USB-A to USB-C
Operating voltage AC	-	-
Charging voltage/current DC	5 V/1 A	5 V/1 A
Power consumption	1.4 W	3.5 W
Charger incl.	No	No
Operating temperature	-10 to +40 °C	-10 to +40 °C
Dimensions	130 x 43 x 29 mm	166 x 46 x 29 mm
Net weight	97 g	205 g
Price	€ 62.90	€ 77.90

UNIFORM series



	SUPERFORM	UV-FORM
Product number	03.5406	03.5408
Light source	COB LED	COB LED Spot: High power UV-light
Adjustable light output	No	2 levels
Beam angle	-	-
CRI	Ra > 80	Ra > 80
CCT	6000 K	6000 K
Operating time with max. lumen, h	-	2.5
Operating time with min. lumen, h	-	5
Charging time, h	-	3
Battery	-	3.7 V/1600 mAh Li-ion
Protection class	IP54	IP20
Impact protection	IK08	IK07
Impact resistance	1 m	1 m
Cable	5 m H05RN-F 2x1 mm ²	1 m USB
Operating voltage AC	100-240 V	-
Charging voltage/current DC	-	5 V/1 A
Power consumption	Max 8 W	Max 3 W
Charger incl.	-	Country-specific
Temperature	-10 to +40 °C	-10 to +40 °C
Dimensions	270 x 49 x 31 mm	155 x 60 x 32 mm
Net weight	710 g	156 g
Price	€ 61.90	€ 79.90

STICK LITE series



	STICK LITE S	STICK LITE M
Product number	03.5665	03.5666
Light source	COB LED	COB LED
Luminous flux, lumen	20-200 Spot: 50	40-400 Spot: 75
Adjustable light output	Stepless	Stepless
Beam angle	110°/35°	110°/35°
CRI	Ra > 80	Ra > 80
CCT	6000 K	6000 K/6000 K
Operating time with max. lumen, h	2	2
Operating time with min. lumen, h	20	20
Charging time, h	2.5	3
Battery	3.7 V/1200 mAh Li-ion	3.7 V/1800 mAh Li-ion
Protection class	IP20	IP20
Impact protection	IK07	IK07
Impact resistance	1 m	1 m
Cable	1 m USB	1 m USB
Operating voltage AC	-	-
Charging voltage/current DC	5 V/1 A	5 V/1 A
Power consumption	Max 2.5 W	Max 4 W
Charger incl.	No	No
Temperature	-10 to +40 °C	-10 to +40 °C
Dimensions	150 x 34 x 13 mm	250 x 34 x 15 mm
Net weight	52 g	88 g
Price	€ 24.90	€ 34.90



	STAR	STAR LITE
Product number	03.5620	03.5671
Light source	COB LED	COB LED
Luminous flux, lumen	500-1000	400
Adjustable light output	2 levels	No
Beam angle	-	-
CRI	Ra > 80	Ra > 80
CCT	6000 K	6000 K
Operating time with max. lumen, h	2.5	-
Operating time with min. lumen, h	5	-
Charging time, h	8	-
Battery	3.7 V/5200 mAh Li-ion	-
Protection class	IP65	IP40
Impact protection	IK07	IK08
Impact resistance	1 m	1 m
Cable	1 m USB	5 m/2 x 1.0 mm ² H05RN-F
Operating voltage AC	-	100-240 V
Charging voltage/current DC	5 V/1 A	-
Power consumption	Max 8.5 W	Max 4.5 W
Charger incl.	Country-specific	-
Temperature	-10 to +40 °C	-10 to +40 °C
Dimensions	156 x 103 x 98 mm	340 x 40 x 25 mm
Net weight	620 g	600 g
Price	€ 99.90	34.90

LINE LIGHT inspection



	LINE LIGHT C+R	LINE LIGHT R
Product number	03.5243	03.5244
Light source	36 SMD LED Spot: CREE XP-G2	20 SMD LED Spot: CREE XP-G2
Luminous flux, lumen	900 Spot: 150	600 Spot: 150
Illuminance, lux@0.5 m	1800 Spot: 1500	1200 Spot: 1500
Adjustable light output	No	No
Beam angle	75° Spot: 50°	75° Spot: 50°
CRI	Ra > 80	Ra > 80
CCT	6500 K	6500 K
Operating time with max. lumen, h	2.5 Spot: 8	1.5 Spot: 4
Operating time with min. lumen, h	-	-
Charging time, h	4	6
Battery	3.7 V/5200 mAh Li-ion	3.7 V/2600 mAh Li-ion
Protection class	IP65	IP65
Impact protection	IK07	IK07
Impact resistance	1 m	1 m
Cable	5 m/2 x 1 mm ² H05RN-F	1 m USB
Operating voltage AC	-	-
Charging voltage/current DC	4.2 V/3.5 A	5 V/1 A
Power consumption	Max 8 W	Max 5.5 W
Charger incl.	Yes	Country-specific
Temperature	-10 to +40 °C	-10 to +40 °C
Dimensions	ø25 x 461 mm	ø25 x 357 mm
Net weight	300 g	220 g
Price	€ 104.90	€ 92.90

BONNET LIGHTS



	LINE LIGHT BONNET C+R	NOVA BONNET
Product number	03.5240	03.5457
Light source	64 SMD LED	High efficiency COB LED
Luminous flux, lumen	700-1400	200-2000
Illuminance, lux@0.5 m	1000-2000	
Adjustable light output	2 levels	5 levels
Beam angle	75°	-
CRI	Ra > 80	Ra > 80
CCT	6500 K	6000 K
Operating time with max. lumen, h	1.5	2
Operating time with min. lumen, h	3	20
Charging time, h	4	5
Battery	3.7 V/5200 mAh Li-ion	7.3 V/4000 mAh Li-ion
Protection class	IP65	IP67
Impact protection	IK07	IK07
Impact resistance	1 m	1 m
Cable	5 m/2 x 1.0 mm ² H05RN-F	1 m USB
Operating voltage AC	-	-
Charging voltage/current DC	4.2 V/3.5 A	5 V/2 A
Power consumption	Max 13 W	Max 16 W
Charger incl.	Yes	Yes
Temperature	-10 to +40 °C	-10 to +40 °C
Dimensions	ø25 x 1017 mm	1135 x 220 x 163 mm
Net weight	470 g (980 g incl. rack)	1.69 kg (NOVA R 790 g)
Price	€ 169.90	€ 149.90

Headlamps



	ZONE 2	ZOOM
Product number	03.5850	03.5627
Light source	COB LED	LED
Luminous flux, lumen	20/100/200 (Step 1/2/3)	10/80/220 (Step 1/2/3)
Adjustable light output	3 levels	3 levels
Beam angle	120°/60°	10°/60°
CRI	Ra > 80	Ra > 80
CCT	6000 K	6000 K
Operating time with max. lumen, h	2	4.5
Operating time with min. lumen, h	22	19
Charging time, h	2.5	2.5
Battery	3.7 V/1200 mAh Li-ion	3.7 V/2000 mAh Li-ion
Protection class	IP54	IP54
Impact protection	IK07	IK07
Impact resistance	1 m	1 m
Cable	1 m USB	1 m USB
Operating voltage AC	-	-
Charging voltage/current DC	5 V/1 A	5 V/1 A
Power consumption	Max 2.5 W	Max 5.5 W
Charger incl.	No	No
Temperature	-10 to +40 °C	-10 to +40 °C
Dimensions	84 x 31 x 37 mm	78 x 46.4 x 46.6 mm
Net weight	75 g	109 g
Price	€ 39.90	€ 29.90



	NEW I-VIEW
Product number	03.6212
Light source	High efficiency multi-LED design with 12 LEDs
Luminous flux, lumen	40-400
OPTILight setting	500 lux@0.5 m
Adjustable light output	3 levels
Beam angle	120° x 60°
CRI	Ra > 80
CCT	5700 K
Operating time max./min. lumen, h	2/21
Operating time OPTILight, h	4
Charging time, h	4.5
Battery	3.7 V/1400 mAh Li-ion
Verified no. of charging cycles	Min. 1000
Protection class	IP65
Rough service	Yes
Impact protection	IK07
Impact resistance	2 m
Cable	1 m USB-A to USB-C
Operating voltage AC	-
Charging voltage/current DC	5 V/1 A
Power consumption	2.6 W
Charger incl.	No
Operating temperature	-10 to +40 °C
Dimensions	99 x 50 x 40 mm
Net weight	130 g
Price	€ 71.90



ACCESSORIES

		Product number	Price
	HARD HAT BRACKET For 03.6212 I-VIEW 103 x 33.5 x 28 mm 22 g	03.5797	€ 14.90
	ADHESIVE MOUNTING BASES For 03.5797 HARD HAT BRACKET	03.5798	€ 7.90

HEAD LITE series



	HEAD LITE S	HEAD LITE A	HEAD LITE
Product number	03.5645	03.5670	03.5669
Light source	COB LED	COB LED	COB LED Spot: 1 SMD LED
Luminous flux, lumen	100	15-150	15-150 Spot: 75
Adjustable light output	Stepless	Stepless	Stepless
Beam angle	110°	120°/100°	120°/100° Spot: 15°
CRI	Ra > 80	Ra > 80	Ra > 80
CCT	6000 K	6000 K	6000 K/6000 K
Operating time with max. lumen, h	1	6	1.5
Operating time with min. lumen, h	10	60	15
Charging time, h	-	-	3
Battery	Excl. (use 2 x AAA 1.5 V Alkaline)	3 x AAA 1.5 V Alkaline	3.7 V/800 mAh Li-ion
Protection class	IP30	IP54	IP54
Impact protection	IK07	IK07	IK07
Impact resistance	1 m	1 m	1 m
Cable	-	-	1 m USB
Operating voltage AC	-	-	-
Charging voltage/current DC	5 V/1 A	5 V/1 A	5 V/1 A
Power consumption	Max 1.5 W	Max 2 W	Max 2 W
Charger incl.	-	-	No
Temperature	-10 to +40 °C	-10 to +40 °C	-10 to +40 °C
Dimensions	55 x 32.5 x 22 mm	70 x 35 x 40 mm	74 x 41 x 41 mm
Net weight	65 g	100 g	73 g
Price	€ 14.90	€ 21.90	€ 32.90

Lighting to wear



	FLEX WEAR
Product number	03.5810
Light source	COB LED/LED
Luminous flux, lumen	75/150 (Step 1/2) Spot: 100
Adjustable light output	2 levels
Beam angle	110°/14°
CRI	Ra > 80
CCT	6000 K
Operating time with max. lumen, h	2
Operating time with min. lumen, h	4
Charging time, h	2.5
Battery	3.7 V/800 mAh Li-ion
Protection class	IP20
Impact protection	IK07
Impact resistance	1 m
Cable	1 m USB
Operating voltage AC	-
Charging voltage/current DC	5 V/1 A
Power consumption	Max 1.5 W
Charger incl.	No
Temperature	-10 to +40 °C
Dimensions	89 x 26 x 21 mm
Net weight	42 g
Price	€ 30.90



FLEX WEAR KIT

	Product number	Price
<p>FLEX WEAR KIT: FLEX WEAR including headband and cap mount</p>	03.5811	€ 41.90

NOVA
rechargeable series



	NEW NOVA MINI	NEW NOVA R	NEW NOVA 4 C+R	NEW NOVA 6 C+R
Product number	03.6200	03.6201	03.6204	03.6205
Light source	High efficiency multi-LED design with 26 LEDs	High efficiency multi-LED design with 44 LEDs	High efficiency multi-LED design with 90 LEDs	High efficiency multi-LED design with 120 LEDs
Luminous flux, lumen	100-1000	200-2000	400-4000	600-6000
OPTILight setting	500 lux@0.5 m	500 lux@1 m	200 lux@2 m	200 lux@2 m
Adjustable light output	6 levels	6 levels	6 levels	6 levels
Beam angle	100°	110°	110°	110°
CRI	Ra > 80	Ra > 80	Ra > 80	Ra > 80
CCT	5700 K	5700 K	5700 K	5700 K
Operating time max./min. lumen, h	1.5/18	1.5/17	2/18	1.5/15
Operating time OPTILight, h	6	3	3.5	4.5
Charging time, h	4	5.5	3	3.5
Battery	3.6 V/3200 mAh Li-ion	7.2 V/3200 mAh Li-ion	18.5 V/2600 mAh Li-ion	18 V/3200 mAh Li-ion
Verified no. of charging cycles	Min. 1000	Min. 1000	Min. 1000	Min. 1000
Protection class	IP65	IP67	IP67	IP67
Rough service	Yes	Yes	Yes	Yes
Impact protection	IK07	IK07	IK07	IK07
Impact resistance	2 m	2 m	2 m	2 m
Cable	1 m USB-A to USB-C	1 m USB-A to USB-C	5 m/2 x 0.75 mm ² H05RN-F	5 m/2 x 0.75 mm ² H05RN-F
Operating voltage AC	-	-	-	-
Charging voltage/current DC	5 V/1 A	5 V/1 A	24 V/1.5 A	24 V/2 A
Power consumption	7.3 W	14 W	25 W	37 W
Charger incl.	No	No	Yes	Yes
Operating temperature	-10 to +40 °C	-10 to +40 °C	-10 to +40 °C	-10 to +40 °C
Dimensions	102 x 39 x 94 mm	166 x 60 x 167 mm	235 x 82 x 235 mm	273 x 88 x 270 mm
Net weight	278 g	840 g	1.98 kg	2.58 kg
Price	€ 74.90	€ 104.90	€ 214.90	€ 254.90

NOVA
cable series



	NEW NOVA 4	NEW NOVA 6	NEW NOVA 12
Product number	03.6202	03.6203	03.6206
Light source	High efficiency multi-LED design with 90 LEDs	High efficiency multi-LED design with 120 LEDs	High efficiency multi-LED design with 200 LEDs
Luminous flux, lumen	400-4000	600-6000	1200-12000
OPTILight setting	200 lux@2 m	200 lux@2 m	200 lux@4 m
Adjustable light output	6 levels	6 levels	6 levels
Beam angle	110°	110°	110°
CRI	Ra > 80	Ra > 80	Ra > 80
CCT	5700 K	5700 K	5700 K
Operating time max./min. lumen, h	-	-	-
Operating time OPTILight, h	-	-	-
Battery	-	-	-
Protection class	IP67	IP67	IP67
Rough service	Yes	Yes	Yes
Impact protection	IK07	IK07	IK07
Impact resistance	2 m	2 m	2 m
Cable	5 m/H07RN-F 3G1.0 mm ²	5 m/H07RN-F 3G1.0 mm ²	5 m/H07RN-F 3G1.0 mm ²
Operating voltage AC	100-240 V	100-240 V	100-240 V
Charging voltage/current DC	-	-	-
Power consumption	29 W	41 W	81 W
Charger incl.	-	-	-
Operating temperature	-25 to +40 °C	-25 to +40 °C	-25 to +40 °C
Dimensions	235 x 80 x 235 mm	273 x 87 x 270 mm	310 x 105 x 305 mm
Net weight	2.42 kg	3.04 kg	4.62 kg
Price	€ 134.90	€ 154.90	€ 284.90

VEGA LITE series



	VEGA LITE C+R	VEGA LITE COMPACT	VEGA LITE	VEGA LITE COLOUR
Product number	03.5451	03.5673	03.5453	03.5459
Light source	66 SMD LED	83 SMD LED	123 SMD LED	123 SMD LED
Luminous flux, lumen	1250-2500	4000	6000	5000
Adjustable light output	2 levels	-	-	-
Beam angle	100°	100°	100°	100°
CRI	Ra > 80	Ra > 80	Ra > 80	Ra > 80
CCT	6000 K	6000 K	6000 K	2500 K - 4500 K - 6500 K
Operating time with max. lumen, h	1.5	2	-	-
Operating time with min. lumen, h	3	20	-	-
Charging time, h	1.5	5	-	-
Battery	11.1 V/2600 mAh Li-ion	7.3 V/4000 mAh Li-ion	-	-
Protection class	IP54	IP54	IP54	IP54
Impact protection	IK07	IK07	IK07	IK07
Impact resistance	-	-	-	-
Cable	5 m/2 x 0.75 mm ² H05RN-F	3 m/3 x 1.5 mm ² H05RN-F	5 m/3 x 1.5 mm ² H07RN-F	5 m/3x1.5 mm ² H07RN-F
Operating voltage AC	100-240 V	100-240 V	100-240 V	100-240 V
Charging voltage/current DC	12.6 V/2.4 A	-	-	-
Power consumption	Max 18 W	Max 32 W	Max 45 W	Max 45 W
Charger incl.	Yes	-	-	-
Temperature	-10 to +40 °C	-10 to +40 °C	-10 to +40 °C	-10 to +40 °C
Dimensions	288 x 103 x 280 mm	288 x 103 x 280 mm	318 x 117 x 310 mm	318 x 117 x 310 mm
Net weight	2.59 kg	2.46 kg	3.43 kg	3.50 kg
Price	€ 134.90	€ 134.90	€ 154.90	€ 179.90

AREA LITE 360°



	AREA LITE CO
Product number	03.5637
Light source	168 SMD LED
Luminous flux, lumen	6000
Adjustable light output	No
Beam angle	360°
CRI	Ra > 80
CCT	6000 K
Operating time with max. lumen, h	-
Operating time with min. lumen, h	-
Charging time, h	-
Battery	-
Protection class	IP54
Impact protection	IK07
Impact resistance	1 m
Cable	5 m/3 x 1.5 mm ² H07RN-F
Operating voltage AC	220-240 V
Charging voltage/current DC	-
Power consumption	Max 45 W
Charger incl.	-
Temperature	-10 to +30 °C
Dimensions	305 x 199 mm
Net weight	2.95 kg
Price	€ 164.90



SEE MORE ABOUT
VEGA LITE COLOUR

SCANGRIP PRODUCT LINES



Specialized work lights
for the painting industry



Explosion proof lights



Portable lights for fast curing



One lighting solution
for all battery packs

SITE LIGHT series



	SITE LIGHT 40	SITE LIGHT 80
Product number	03.5268	03.5269
Light source	432 SMD LEDs	864 SMD LEDs
Luminous flux, lumen	10000-40000	20000-80000
Adjustable light output	4 levels	4 levels
Beam angle	120°	120°
CRI	Ra > 80	Ra > 80
CCT	6000 K	6000 K
Operating time with max. lumen, h	-	-
Operating time with min. lumen, h	-	-
Charging time, h	-	-
Battery	-	-
Protection class	IP65	IP65
Impact protection	IK08	IK08
Impact resistance	1 m	1 m
Cable	10 m/3 x 1 mm ² H07RN-F	10 m/3 x 1 mm ² H07RN-F
Operating voltage AC	220-240 V	220-240 V
Charging voltage/current DC	-	-
Power consumption	Max 315 W	Max 630 W
Charger incl.	-	-
Temperature	-25 to +40 °C	-25 to +40 °C
Dimensions	278 x 241 x 160 mm	415 x 241 x 160 mm
Net weight	4.95 kg	6.70 kg
Price	€ 669.90	€ 1069.90

	NEW ROPE LIGHT
Product number	03.5815
Light source	120 SMD LEDs /m
Luminous flux, lumen	20000
Adjustable light output	No
Beam angle	120°
CRI	Ra >80
CCT	6000 K
Operating time with max. lumen, h	-
Operating time with min. lumen, h	-
Charging time, h	-
Battery	-
Protection class	IP65
Impact protection	IK07
Impact resistance	1 m
Cable	1.5 m/2 x 1.0 mm ² H05RN-F
Operating voltage AC	220-240 V
Charging voltage/current DC	-
Power consumption	Max 205 W
Charger incl.	-
Temperature	-20 to +40 °C
Dimensions	ø200 x 325 mm
Net weight	4.68 kg
Price	€ 399.90



SEE MORE ABOUT ROPE LIGHT

ACCESSORIES		Product number	Price
	SCANGRIP TRIPOD 4.5m Air cushioned tripod for positioning of SITE LIGHTs, 2.2 - 4.5 m 17 kg Max load 20 kg	03.5270	€ 314.90
	DUAL BRACKET for 4.5m TRIPOD For positioning of two SITE LIGHTs	03.5758	€ 59.90
	TRANSPORT CASE SITE LIGHT 80	49.0351	€ 171.90
	TRANSPORT CASE SITE LIGHT 40 <small>The transport cases enable you to safely transport your SITE LIGHT work light to the building site. They are sturdy and high-quality cases that can withstand shocks and rough handling during transport.</small>	49.0350	€ 96.90

Go to scangrip.com to see other accessories available



SEE MORE ABOUT SITE LIGHT

MINI LITE A

LITE

	MINI LITE A
Product number	03.5102
Light source	LG
Luminous flux, lumen	100
Adjustable light output	No
Beam angle	10°
Beam distance	Up to 80 m
CRI	Ra > 75
CCT	6000 K
Operating time with max. lumen, h	4.5
Operating time with min. lumen, h	-
Charging time, h	-
Battery	3 x AAA/1.5 V Alkaline
Protection class	IP54
Impact resistance	1 m
Cable	-
Operating voltage AC	-
Charging voltage/current DC	-
Power consumption	Max 2 W
Charger incl.	-
Temperature	-10 to +40 °C
Dimensions	ø28 x 102 mm
Net weight	72 g
Price	€ 8.90

FLASH series



	FLASH PENCIL	FLASH PEN	FLASH 300	FLASH 600	FLASH MICRO R
Product number	03.5130	03.5131	03.5132	03.5133	03.5113
Light source	LUMILEDS	CREE	CREE	CREE	LED
Luminous flux, lumen	75	100-200	150-300	300-600	7.5-75
Adjustable light output	No	BOOST mode	BOOST mode	BOOST mode	Stepless
Beam angle	15°	10°-60°	10°-60°	10°-60°	110°
Beam distance	40 m	80 m	100 m	150 m	10 m
CRI	Ra > 70	Ra > 70	Ra > 65	Ra > 65	Ra > 80
CCT	6000 K	6000 K	6000 K	6000 K	6000 K
Operating time with max. lumen, h	2.5	3.5	3	2	0.25
Operating time with min. lumen, h	-	-	-	-	2.5
Charging time, h	-	-	-	-	2.5
Battery	2 x AAAA/1.5 V Alkaline	2 x AAA/1.5 V Alkaline	3 x AAA/1.5 V Alkaline	2 x C/1.5 V Alkaline	3.7 V/100 mAh Li-ion
Protection class	IP54	IP54	IP54	IP54	IP20
Impact protection	IK07	IK07	IK07	IK07	-
Impact resistance	1 m	1 m	1 m	1 m	1 m
Cable	-	-	-	-	USB cable
Charging voltage/current DC	-	-	-	-	-
Power consumption	Max 1.6 W	Max 1.2 W	Max 4.8 W	Max 7 W	Max 1.2 W
Charger incl.	-	-	-	-	-
Temperature	-10 to +40 °C	-10 to +40 °C	-10 to +40 °C	-10 to +40 °C	-10 to +40 °C
Dimensions	ø15 x 131 mm	ø20 x 153 mm	ø32 x 133 mm	ø36 x 174 mm	55 x 15 x 25 mm
Net weight	32 g	62 g	122 g	292 g	17 g
Price	€ 19.90	€ 27.90	€ 34.90	€ 44.90	€ 14.90

FLASH R series



	FLASH 12-24V	WORK PEN 200 R	FLASH PEN R	FLASH 600 R	FLASH 1000 R
Product number	03.5124	03.5127	03.5136	03.5137	03.5138
Light source	SAMSUNG LED	COB LED/CREE	CREE	CREE	CREE
Luminous flux, lumen	130	20-200 Spot: 150	150-300	300-600	500-1000
Adjustable light output	No	Stepless	BOOST mode	BOOST mode	BOOST mode
Beam angle	10°-70°	105°/20°	10°-60°	10°-70°	10°-60°
Beam distance	100 m	40 m	100 m	150 m	250 m
CRI	Ra > 70	Ra > 80	Ra > 65	Ra > 65	Ra > 70
CCT	6000 K	6000 K	6000 K	6000 K	6000 K
Operating time with max. lumen, h	1	1	7	7	5
Operating time with min. lumen, h	-	10	-	-	-
Charging time, h	2	2.5	3	4	4
Battery	3.7 V/550 mAh Li-ion	3.7 V/750 mAh Li-ion	3.7 V/1100 mAh Li-ion	3.7 V/2600 mAh Li-ion	3.7 V/4000 mAh Li-ion
Protection class	IP30	IP30	IP54	IP54	IP54
Impact protection	IK07	IK07	IK07	IK07	IK07
Impact resistance	1 m	1 m	1 m	1 m	1 m
Cable	Cigarette Plug Connector	1 m USB	1 m USB	1 m USB	1 m USB
Charging voltage/current DC	10-28 V	5 V/1 A	5 V/1 A	5 V/1 A	5 V/2 A
Power consumption	Max 2 W	4 W	4 W	6 W	12 W
Charger incl.	No	No	No	No	No
Temperature	-10 to +40 °C	-10 to +40 °C	-10 to +40 °C	-10 to +40 °C	-10 to +40 °C
Dimensions	ø30 x 105 mm	ø21 x 172 mm	ø24 x 169 mm	ø38 x 185 mm	ø42 x 196 mm
Net weight	88 g (100 g with cover)	54 g	83 g	253 g	345 g
Price	€ 29.90	€ 29.90	€ 39.90	€ 59.90	€ 69.90

LINE LIGHT series



	LINE LIGHT 2-POST	LINE LIGHT 1	LINE LIGHT 2	LINE LIGHT 4	LINE LIGHT 6
Product number	03.5225	03.5203	03.5202	03.5201	03.5200
Light source	2 x 96 SMD LED	216 SMD LED	2 x 156 SMD LED	4 x 216 SMD LED	6 x 216 SMD LED
Luminous flux, lumen	2 x 12.5-1250	2750	2 x 2000	4 x 2750	6 x 2750
Illuminance, lux@0.5 m	2 x 20-2000	3000	2 x 2800	4 x 27.5-2750	6 x 3000
Adjustable light output	Stepless	No	No	Stepless	No
Beam angle	75°	75°	75°	75°	75°
CRI	Ra > 80	Ra > 80	Ra > 80	Ra > 80	Ra > 80
CCT	6000 K	6000 K	6000 K	6000 K	6000 K
Operating time with max. lumen, h	-	-	-	-	-
Operating time with min. lumen, h	-	-	-	-	-
Charging time, h	-	-	-	-	-
Battery	-	-	-	-	-
Protection class	IP67	IP67	IP67	IP67	IP67
Impact protection	IK07	IK07	IK07	IK07	IK07
Impact resistance	1 m	1 m	1 m	1 m	1 m
Cable	8 m/H03VV-F 2 x 0.5 mm ²	8 m/H03VV-F 2 x 0.5 mm ²	8 m/H03VV-F 2 x 0.5 mm ²	8 m/H03VV-F 2 x 0.5 mm ²	8 m/H03VV-F 2 x 0.5 mm ²
Operating voltage AC	-	-	-	-	-
Charging voltage/current DC	24 V	24 V	24 V	24 V	24 V
Power consumption	Max 2 x 24 W	Max 26 W	Max 2 x 38 W	Max 4 x 104 W	Max 6 x 156 W
Power supply incl.	25 W POWER SUPPLY UNIT 03.5229	25 W POWER SUPPLY UNIT 03.5229	80 W POWER SUPPLY UNIT 03.5226	80 W POWER SUPPLY UNIT 03.5226	2 x 80 W POWER SUPPLY UNIT 03.5226
Temperature	-10 to +40 °C	-10 to +40 °C	-10 to +40 °C	-10 to +40 °C	-10 to +40 °C
Dimensions	2 x ø25 x 770 mm	ø25 x 1630 mm	2 x ø25 x 1234 mm	4 x ø25 x 1630 mm	6 x ø25 x 1630 mm
Net weight*	4.1 kg	2.03 kg	4.52 kg	6.7 kg	10.24 kg
Price	€ 403.90	€ 241.90	€ 393.90	€ 1009.90	€ 1514.90

*Weight includes all parts and accessories included

LINE LIGHT series



	LINE LIGHT 75	LINE LIGHT 120	LINE LIGHT 160	LINE LIGHT 200
Product number	03.5221	03.5222	03.5223	03.5224
Light source	96 SMD LED	156 SMD LED	216 SMD LED	276 SMD LED
Luminous flux, lumen	1250	2000	2750	3500
Illuminance, lux@0.5 m	2000	2800	3000	3200
Adjustable light output	No	No	No	No
Beam angle	75°	75°	75°	75°
CRI	Ra > 80	Ra > 80	Ra > 80	Ra > 80
CCT	6000 K	6000 K	6000 K	6000 K
Operating time with max. lumen, h	-	-	-	-
Operating time with min. lumen, h	-	-	-	-
Charging time, h	-	-	-	-
Battery	-	-	-	-
Protection class	IP67	IP67	IP67	IP67
Impact protection	IK07	IK07	IK07	IK07
Impact resistance	1 m	1 m	1 m	1 m
Cable	-	-	-	-
Operating voltage AC	-	-	-	-
Charging voltage/current DC	24 V	24 V	24 V	24 V
Power consumption	Max 10 W	Max 16 W	Max 22 W	Max 28 W
Power supply incl.	-	-	-	-
Temperature	-10 to +40 °C	-10 to +40 °C	-10 to +40 °C	-10 to +40 °C
Dimensions	ø25 x 838 mm	ø25 x 1234 mm	ø25 x 1630 mm	ø25 x 2027 mm
Net weight*	390 g	530 g	670 g	860 g
Price	€ 120.90	€ 201.90	€ 231.90	€ 272.90

Embracing a more sustainable mindset

SCANGRIP is taking a strategic step forward to reinvent how professional LED work lights are made and how they impact the environment.

The FOR LIFE concept marks a new approach to designing LED work lights that are more long-lasting. As part of this sustainability focus, products marked with the FOR LIFE symbol have undergone a complete transformation when it comes to visual design and enhanced features.



Recycled materials have been incorporated wherever physically possible in both the product design and packaging. The packaging is made from 100 % recycled materials and completely free of any plastic parts. Moreover, our printed brochures carry the Nordic Swan Ecolabel.

These changes represent just the first steps in our ongoing dedication to innovation and environmental responsibility.

Made from
RECYCLED
material

Product: **44 %**

Packaging: **100 %**



Packaging contains no plastic parts



Combine LINE LIGHT lighting units with power supply, cable and suitable suspensions.

A range of flexible suspensions makes it possible to position the lighting units exactly where you need it.

POWER SUPPLY/CABLE		Product number	Price
	LINE LIGHT DIMMER	03.5264	€ 70.90
2 m cable	25 W power supply unit	03.5229	€ 31.50
2 m cable	80 W power supply unit	03.5226	€ 51.90
2 m cable	NEW 200 W power supply unit	03.5277	€ 74.90
	POWER CABLE 8 m	03.5215	€ 8.50

SUSPENSIONS		Product number	Price
	CLIP - 1 pc. - incl. fittings for suspension	03.5214	€ 6.70
	CLIP - 1 pc. - incl. fittings for suspension	03.5216	€ 23.90
	CLIP with ø30 mm magnet for suspension	03.5279	€ 20.90
	LARGE MAGNET - ø60 mm with clip	03.5276	€ 26.90
	FLEXIBLE MAGNET SUSPENSION - Ball socket joint with strong magnet for suspension for LINE LIGHT 2-POST	03.5257	€ 42.90
	MAGNET - With small clip - ø30 mm	03.5246	€ 15.90
	CLIP - Small metal clip	03.5213	€ 4.20

Go to scangrip.com to see other accessories available





SCANGRIP is Europe's leading manufacturer of work lights for professionals providing the strongest and most comprehensive ranges of work lights with the latest LED lighting technology available on the market.

SCANGRIP is innovation from Denmark and receives strong recognition in the marketplace for its product design, and the products are known for their high quality.

SCANGRIP strives for perfection, and is continuously optimizing and improving light output, battery capacity, design and ergonomics, durability, user-friendliness, and functionality. The aim is to set new standards for professional work lights.

SCANGRIP was established in 1906 and has a long, impressive history of manufacturing high-quality hand tools and work lights for the industrial, construction, and automotive sectors.

SCANGRIP is part of Hultafors Group - a global company offering a unique portfolio of premium brands within personal protection, tools, and other equipment for discerning craftsmen. Together, we are on a mission to create a better day for professional users.